

ANTIQUE CHEVROLET PARTS

1221 Hwy 5 West, RR 1, Dundas Ontario L9H 5E1
Tel. (905)627-4527 Order 1-866-767-2787 Fax (905)627-3210
www.antiquechev.com info@antiquechev.com



**1962 - 1979 Nova & Acadian
Parts & Accessories**

Volume 9

\$5.00

"Your Satisfaction Is Our Success"



Welcome to Antique Chevrolet Parts

Thank you for taking the opportunity to browse our catalogue. We have filled this catalogue with the largest selection of quality restoration parts on the market today. To that end, we have even gone to the extent to list the same part more than once if it is available from different sources, such as if the part was made in the USA or offshore. It has been our experience that the offshore parts are quite comparable to their US-made counterparts. However, due to the economics of the world, the offshore parts generally tend to be less expensive than the US-made parts. As usual though, there are exceptions to this rule and we will do our best to advise you if there is a tangible difference between the parts. As the restoration parts market is ever-expanding, it is impossible to list every item that is available in this catalogue. Therefore, if you don't see something listed in our catalogue that you need, please give us a call and we will see if we can get it for you. Sometimes these "quotes" can take some time as our orders must take priority, but we will answer your questions as quickly as we can. Thank you for your patience and understanding in this regard. As you can see, our parts catalogue and our price list are separate. We have taken this route in an effort to keep you as informed and as up to date as possible. It is much easier to update separate price lists and catalogues than it is if they are combined. We believe that this catalogue will be one of the most helpful tools that you will have in the restoration of your vehicle.

ORDERING INFORMATION

We gladly accept orders over the telephone, by fax, mail, email and of course if you are in the area, at our shop. No matter what the method, the procedure remains basically the same.

In most cases, we will require all of your vehicle information, your name, address and a daytime telephone number. Please be prepared with the part numbers and part descriptions that you require. All orders must be accompanied by a Visa or a MasterCard number and expiration date for security purposes.

Please contact us using your method of choice, and we will get your order rolling.

Please note that we don't have a secure web site at this time for ordering purposes. Also, please do not include any credit card information via email. Please call with this information.

OBTAINING YOUR ORDER

PICKING YOUR ORDER UP

If you are local to us, and you would like to pick your order up, you are welcome to do so. We look forward to meeting our customers in person whenever possible. **No need to call us to see if your order is in, because we will call you as soon as we have all, or the majority of your order.** Once we have notified you that your order is ready for pick up, you have one week to contact us to arrange pick up and payment. **After one week, if you haven't made arrangements for pick up and payment of your order, you will be contacted and advised that payment of your order will be charged to the credit card that you provided us with at the time that your order was initially placed.** You can then pick up your order at your earliest convenience. Otherwise, parts may be returned to stock and the order may be considered cancelled.

HAVING YOUR ORDER SHIPPED

If you are not local to us, we can ship your order to you. We try to get as much of your order together as possible before we ship it to you in order to keep your shipping costs down. If we have to backorder an item or items to you, we will follow up with subsequent shipments when it seems reasonable to do so. However, if you have specific needs, let us know and we will try our best to accommodate you. We can ship to either residential or business addresses, although it is best to have the order shipped to a business address. Certain oversized items can only be shipped to a business address, which we will advise when necessary. All orders are insured against loss or damage.

We typically use Canada Post, CanPar and Fedex for our carriers. We have found them to be the most reliable and economical carriers. If you have another preferred carrier, **we must be provided with your specific account number with that carrier.** A packaging & handling fee will still apply, based on the time and materials required to package the shipment and completing your carrier's documentation.

For some larger shipments we must use a trucking firm. We will decide which one is best at the time of the shipment. It is preferred that we are provided with a business address when these truck shipments are required.

In some cases, we may have your parts drop shipped directly from the supplier. In these cases, the supplier uses the best means possible based on their experience. Choosing your own carrier in these cases is not possible.

In most cases the shipping charge cannot be determined until the shipment has been packaged. The rate is determined by the destination and the weight (either by actual weight or by dimensional volume) of the shipment. Therefore, if required, we can only estimate the cost of a particular shipment.

Handling charges are dependent upon the time and materials required to package the shipment. In any event, our handling charges are more than reasonable given the care and diligence required to ensure that your goods are packaged safely.

Our minimum "Shipping & Handling" charges are \$3.00 for an envelope and \$12.00 for the smallest boxed shipment. We combine the two charges into one on your invoice.

Please inspect the condition of the packaging of your shipment when received before you sign for it. If there are any visible signs of damage, note them in writing with the carrier. In most cases like this, we will provide you with a replacement shipment and we will handle the damage claim with the carrier. The damaged item is usually retained by the carrier or returned to us.

If you receive a shipment, sign for it, and then notice that it is damaged, contact the carrier right away. You then must contact us. Keep all packaging and parts related to the shipment. They may be required if an inspection of the damaged shipment needs to be made. Once again, in most cases, a replacement shipment is made to you and we handle the damage claim with the carrier. The carrier will usually retain the damaged item.

Lost shipments are replaced by us and the loss claim is handled by us.

On occasion and subject to approval, we will send a shipment "Cash on Delivery". We prefer not to, but we may on occasion to do so for our customers, depending on the circumstances. An extra COD fee applies. Payment in advance by certified cheque or money order may be required instead.

INSPECTING YOUR PARTS

Whether you have picked your parts up at our shop or if we have shipped them to you, inspect them as soon as you get them! Please check and make sure that what you received is what you were invoiced for; check the colour, check the fit, check the descriptions on the labels, check, check, check! We realize that parts can be stockpiled months in advance of use, but the longer you have something, the more difficult it is for us to rectify a problem, either internally or with our suppliers. Please help us to avoid a possible uncomfortable situation and **inspect your parts thoroughly as soon as you receive them and let us know within 30 days.**

If a problem arises with an order that you have received, please contact us right away and we will do everything possible resolve the problem to everyone's mutual satisfaction.

Welcome to Antique Chevrolet Parts

AVAILABILITY OF PARTS

We stock a large selection of these items in our warehouse in Dundas and we draw from a number of local sources, where possible, which helps make delivery times better than ever. If we don't have something in stock, delivery times to us vary from a couple of days to two to three weeks, depending on the source. We can "put a rush" on parts that we have to order in, but that usually involves air freight from the USA which tends to be **very** expensive. Also, many of these parts are manufactured when we order them and the manufacturers are generally unwilling or unable to adjust their production schedules to accommodate specific requests. We know that you want your parts quickly and we will do our best to get them for you as quickly as possible.

On occasion, certain items may be on backorder from our preferred supplier. In cases such as this, please let us know if you would like us to try a secondary source. The price of the part may be a little more, but sometimes if you need something quickly, it is unavoidable. Consider also that this option is not always available to us.

EXCHANGES AND RETURNS

If for some reason you need to exchange something, we typically need to receive the part that you wish to exchange back at our shop for inspection before we can consider replacement. If you are not local to us, you may be required to mail back (by Canada Post ground service) the item to be exchanged. If applicable, return freight costs will be refunded to you. All exchanges must be authorized in advance and accompanied by a copy of your receipt of the original purchase. **A 30 day time limit applies to all exchanges & returns.**

All returns must be authorized and accompanied by a copy of your receipt of the original purchase. Returns may be subject to restocking charges. The restocking charge depends on what is being returned, but it is typically 30%. Some items such as literature, electrical items, wiring and special order items are non returnable. All return shipments must be prepaid.

PRICING

We do our best to establish our prices at a reasonable and competitive level. Due to fluctuations in the Canadian dollar and ever changing supplier costs, this can be a challenge. Rest assured that we are constantly updating our prices and we will do our best to keep prices accurate and competitive. If there has been a dramatic price change in an item that you have ordered, we will let you know about it.

WEBSITE

Check our website from time to time as we update our "Current Specials", with new parts offered at introductory prices, close-outs and over-stock items priced to sell here at Antique Chevrolet Parts. Check it out at www.antichechev.com

Table Of Contents

| | |
|---|---------|
| Exterior Emblems, Scrpts & Ornaments | Page 4 |
| Exterior Mouldings, Chrome Parts & Trim | Page 6 |
| Weatherstrips, Gaskets & Rubber Parts | Page 12 |
| Lights, Lenses & Related | Page 16 |
| Switches & Harnesses | Page 18 |
| Underhood & Drivetrain Parts | Page 22 |
| Door Related & Locks | Page 31 |
| Decals | Page 33 |
| Clips & Fasteners | Page 36 |
| Sheet Metal | Page 38 |
| Literature | Page 43 |
| Interior | Page 44 |
| RetroSound | Page 54 |
| Custom Autosound | Page 56 |
| Index | Page 60 |

STORE HOURS

Our store hours are as follows:

| | |
|--------------------------------|----------------------|
| Monday through Friday | 9:00 am to 5:30 pm |
| Saturday | 9:00 am to 12:00 pm |
| Saturdays During Long Weekends | For our staff Closed |
| Sunday & Statutory Holidays | Closed |

These hours can vary due to flea markets, seasonal needs, vacations or personal situations. **It is a good idea to always phone first!**

OUR GOALS

Our goals are to supply the best quality parts at competitive prices in a timely fashion all while treating our valued customers with respect and dignity. If there are any problems, we will do our very best to resolve them in a timely and mutually satisfactory manner. We hope that you can appreciate our goals and that you will work together as you proceed with your restoration, whether it be one or two parts, or a complete vehicle!

Thank you. Hope to hear from you soon. All of us at Antique Chevrolet Parts

Restoration Parts for Chevy Cars and Trucks 1937-1981

- 1937-1948
- 1949-1954
- 1955-1957
- 1958-1976
- Chevelle, Beaumont, ElCamino, Monte Carlo
- Nova, Acadian
- Camaro, Firebird
- Chevrolet, GMC Trucks
- Our Story
- Our Suppliers
- Contact Us
- Download A Catalogue

Antique Chevrolet Parts
Monday, 29-Aug-2011 12:07:16 EDT



1221 Hwy 5 W, RR#1
Dundas, Ontario, L9H 5E1
GPS: 43.282815, -80.054838

phone 905.627.4527
toll-free 1.866.767.2787
fax 905.627.3210

Mon to Fri: 9:00am - 5:30pm
Most Sat: 9:00am - 12:00pm

We are closed for statutory holidays and long weekends

Always phone first!

"We hope you'll choose us as your Chevy parts supplier and develop a long-term relationship with us. We promise to do our best to look after your needs."

Visit our  Store!

Car and Truck Appraisal Centre
www.ca.ta.ca

Exterior Emblems, Scripts & Ornaments

| | | | | | |
|---|--|--|-------------|---|---|
|  |  | | | | |
| X100000 | X100250 | | | | |
| HOOD & GRILLE EMBLEMS & ORNAMENTS | | | | | |
| X100000 | 68-72 Hood moulding emblem | | each |  |  |
| X100250 | 68-72 Hood louvers (SS) | | pair | | |
| X100500 | 68-72 Hood ornament bezel (SS) | | each | | |
| X100750 | 66 Grille emblem "SS" | | each | X100750 | |
|  |  | | | |  |
| X100800 | X100810 | | | | X101000 |
| X100800 | 67 Grille emblem "Nova SS" | | each | | |
| X100810 | 67 Grille emblem "Chevy II" | | each | | |
| X101000 | 68-72 Grille emblem "SS" | | each | | |
| X101010 | 73-74 Grille emblem "SS" | | each | | |
| FRONT FENDER EMBLEMS | | | | | |
| X101250 | 62-64 Front fender emblems (6 cyl., black) | | pair |  |  |
| X101260 | 62-64 Front fender emblems (6 cyl., red) | | pair | | |
| X101500 | 62-64 Front fender vees (283) | | pair | | |
| X101750 | 65-67 Front fender flags (283, 327) | | pair | | |
| X102000 | 65 Front fender script "283" | | pair | | |
| X102250 | 65-67 Front fender script "327" | | pair | | |
| | | | | X101250 | X101750 |
|  |  | | |  |  |
| A111000 | A112000 | | | X102000 | X102250 |
| A111000 | 65-67 Front fender flags "396 Turbo Jet" | | pair | | |
| A112000 | 65-67 Front fender flag "427 Turbo Jet" | | each |  |  |
| X102500 | 69-72 Front fender script "Nova" (68 quarter) | | each | X102500 | |
| X103000 | 70 Front fender script "396" | | each | | |
| X103250 | 70-72 Front fender script "350" | | EACH |  | X103250 |
| X103500 | 69-71 Fender louver ornament | | each | | |
| X103600 | 73-74 Front fender or trunk emblem "Nova" | | each | | |
| X103700 | 73-74 Front fender/trunk emblem "SS" | | each | X103700 | |
| REAR QUARTER EMBLEMS | | | | | |
| X104500 | 62 Rear quarter emblems "Nova 400" | | pair | | |
| X105000 | 63-64 Rear quarter emblem "Nova Chevy II" (fits 64 front fender) | | pair |  | |
| X105100 | 63 Rear quarter emblems "Nova SS" | | pair | | |
|  |  | | | | X105000 |
| X105100 | X105150 | | |  |  |
| X105150 | 64 Rear quarter emblems "Nova SS" | | pair | X105750 | X106270 |
| X105250 | 65 Rear quarter emblems "Nova" | | pair | | |
| X105500 | 65 Rear quarter emblems "Nova SS" | | pair | | |
| X105750 | 66-67 Rear quarter emblems "Nova" | | pair | | |
| X106270 | 66-67 Rear quarter emblem "Super Sport" | | each | | |

1962 – 1979 Nova & Acadian Catalogue Volume 9

PHONE: (905)627-4527 ORDERS 1-866-767-2787 FAX (905)627-3210

Exterior Emblems, Scripts & Ornaments

REAR END & TRUNK LID EMBLEMS

| | | | |
|---------|-------|---|------|
| X106000 | 63-64 | Trunk emblem "Nova SS" | each |
| X106250 | 65 | Trunk emblem "Nova SS" | each |
| X106300 | 65 | Rear panel emblem (plastic insert only) | each |
| X106500 | 68 | Trunk emblem "Chevy II By Chevrolet" | each |
| X106750 | 69-72 | Trunk emblem "Nova By Chevrolet" | each |



X106000



X106300



X106500



X106750



X106950

| | | | |
|---------|-------|------------------------|------|
| X106850 | 68-69 | Rear panel emblem "SS" | each |
| X106950 | 70-72 | Rear panel emblem "SS" | each |

MARKER LAMP BEZELS

| | | | |
|---------|-------|---|------|
| X108250 | 68-69 | Marker lamp bezels (307) | pair |
| X108500 | 68-69 | Marker lamp bezels (327) | pair |
| X108750 | 68-69 | Marker lamp bezels (350) | pair |
| X109000 | 68-69 | Marker lamp bezels (396) | pair |
| X109250 | 68-69 | Marker lamp bezels (427) | pair |
| X109500 | 68-69 | Marker lamp bezel (6cyl. front, all rear) | each |
| X109510 | 70-75 | Marker lamp bezel (front) | each |
| X109520 | 70-79 | Marker lamp bezel (70-75 rear)(76-79) | each |



X108500



X109510



1962 – 1979 Nova & Acadian Catalogue Volume 9

PHONE: (905)627-4527 ORDERS 1-866-767-2787 FAX (905)627-3210

Exterior Mouldings, Chrome Parts & Trim

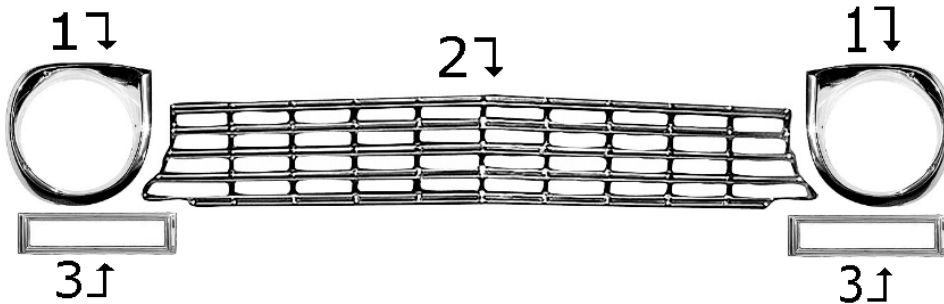

| <u>62-64 NOVA FRONT MOULDINGS</u> | | | | |
|-----------------------------------|---------|-------|--------------------------------|------|
| | X200100 | 62-64 | Hood spear | each |
| 2 | X200600 | 62 | Grille | each |
| | X200605 | 63 | Grille | each |
| | X200610 | 64 | Grille | each |
| 3 | X211000 | 63-64 | Park lamp bezels (will fit 62) | pair |
| | X202000 | 62-64 | Park lamp extension mouldings | pair |
| 1 | X211200 | 62-64 | Headlamp bezels | pair |
| | X212300 | 62-75 | Seal beam retainer | each |



X202000

| <u>65 NOVA FRONT MOULDINGS</u> | | | | |
|--------------------------------|-----------------|-----------|-------------------------------------|-------------|
| | X200615 | 65 | Grille | each |
| | X211250 | 65 | Headlamp bezel (fits left or right) | each |
| | *X211260 | 65 | Headlamp eyebrow mouldings | pair |
| | X212300 | 62-75 | Seal beam retainer | each |

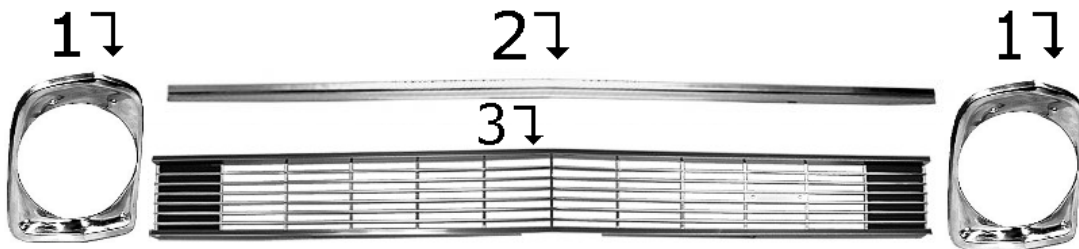

| <u>66 NOVA FRONT MOULDINGS</u> | | | | |
|--------------------------------|---------|-------|---|------|
| 2 | X200200 | 66 | Hood lip moulding | each |
| 3 | X200900 | 66 | Grille | each |
| | X200910 | 66 | Grille mounting brackets (6 pc kit) | kit |
| 1 | X211300 | 66 | Headlamp bezels (Taiwan made, driver quality)(66-67 Acadians) | each |
| | X211400 | 66 | Headlamp bezels (U.S. made) (66-67 Acadians) | each |
| | X212300 | 62-75 | Seal beam retainer | each |



1962 – 1979 Nova & Acadian Catalogue Volume 9

PHONE: (905)627-4527 ORDERS 1-866-767-2787 FAX (905)627-3210

Exterior Mouldings, Chrome Parts & Trim

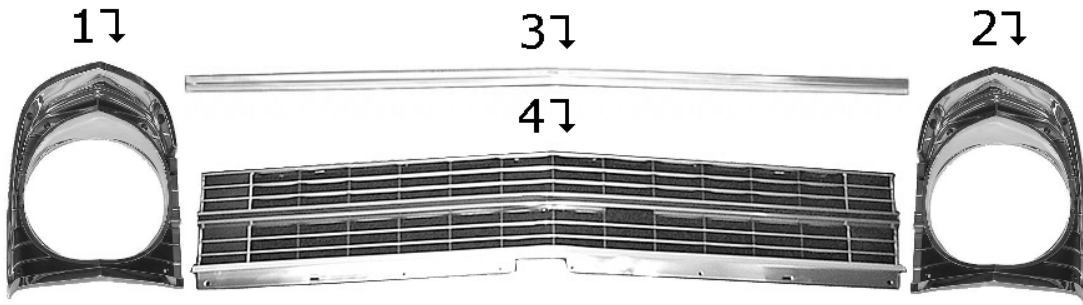

67 NOVA FRONT MOULDINGS

| | | | | |
|---|---------|-------|------------------------|------|
| 3 | X200250 | 67 | Hood lip moulding | each |
| 4 | X200995 | 67 | Grille | each |
| 1 | X211500 | 67 | Headlamp bezel (left) | each |
| 2 | X211750 | 67 | Headlamp bezel (right) | each |
| | X212300 | 62-75 | Seal beam retainer | each |

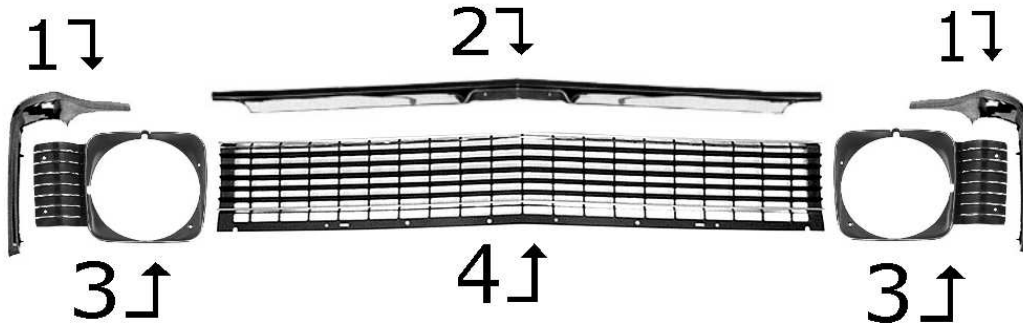

68-72 NOVA FRONT MOULDINGS

| | | | | |
|---|---------|-------|---------------------------------|------|
| 2 | X200500 | 68-72 | Hood lip moulding (Taiwan made) | each |
| | X200525 | 68-72 | Hood lip moulding (U.S. made) | each |
| 1 | X201300 | 68-72 | Front fender eyebrows (Taiwan) | pair |
| | X201350 | 68-72 | Front fender eyebrows (US made) | pair |
| 4 | X201000 | 68-69 | Grille (except SS) | each |
| | X201010 | 68-69 | Grille (SS) | each |
| | X201020 | 70-72 | Grille (except SS) | each |
| | X201030 | 70-72 | Grille (SS) | each |
| 3 | X212220 | 68 | Headlamp bezels | pair |
| | X212260 | 69-72 | Headlamp bezels | pair |
| | X212300 | 62-75 | Seal beam retainer | each |



1968 1969-1972

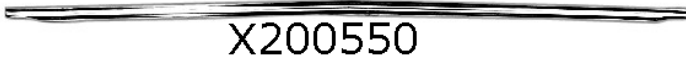

X200550

73-74 NOVA FRONT MOULDINGS

| | | | |
|----------|-------|---------------------|------|
| X200550 | 73-74 | Hood lip moulding | each |
| *X200560 | 73-74 | Grille (SS painted) | each |
| *X200570 | 73-74 | Park lamp bezel | each |
| *X200575 | 73-74 | Park lamp assembly | each |



X200560

62-65 REAR END MOULDINGS

| | | | |
|---------|-------|--------------------------------|------|
| X202300 | 62-65 | Rear cove mouldings (C-shaped) | pair |
| X202350 | 62-65 | Trunk moulding | each |



X202300

1962 - 1979 Nova & Acadian Catalogue Volume 9

PHONE: (905)627-4527 ORDERS 1-866-767-2787 FAX (905)627-3210

Exterior Mouldings, Chrome Parts & Trim

WHEEL WELL OPENING MOULDINGS

| | | | |
|----------|-------|--|--|
| *X203260 | 62-65 | Wheel well opening moulding (left front) each | |
| *X203270 | 62-65 | Wheel well opening moulding (right front) each | |
| *X203280 | 62-65 | Wheel well opening moulding (left rear) each | |
| *X203290 | 62-65 | Wheel well opening moulding (right rear) each | |
| X203300 | 66-67 | Wheel well opening moulding (left front) each | |
| X203310 | 66-67 | Wheel well opening moulding (right front) each | |
| X203320 | 66-67 | Wheel well opening moulding (left rear) each | |
| X203330 | 66-67 | Wheel well opening moulding (right rear) each | |
| *X203340 | 68-72 | Wheel well opening moulding (left front) each | |
| *X203350 | 68-72 | Wheel well opening moulding (right front) each | |
| *X203360 | 68-72 | Wheel well opening moulding (left rear) each | |
| *X203370 | 68-72 | Wheel well opening moulding (right rear) each | |



ROCKER MOULDINGS

| | | | |
|----------|-------|------------------------|------|
| X203800 | 62-63 | Rocker panel mouldings | pair |
| X203800A | 66-67 | Rocker panel mouldings | pair |

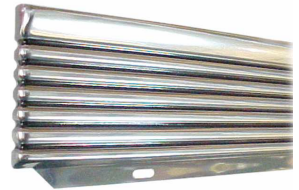

| | | | |
|---------|-------|--|------|
| X204510 | 68-74 | Rocker panel moulding extensions (quarter panel) | pair |
|---------|-------|--|------|

63-64 PEAK MOULDINGS

| | | | |
|---------|-------|--|------|
| X201700 | 63-64 | Body side peak mouldings (SS)(set/8) | set |
| X201730 | 63-64 | Fender peak moulding (SS)(left) | each |
| X201740 | 63-64 | Fender peak moulding (SS)(right) | each |
| X201750 | 63-64 | Door peak moulding (SS)(left) | each |
| X201755 | 63-64 | Door peak moulding (SS)(right) | each |
| X201760 | 63-64 | Quarter peak moulding (SS)(left)(2pc) | each |
| X201780 | 63-64 | Quarter peak moulding (SS)(right)(2pc) | each |



66 SIDE MOULDINGS

| | | | |
|---------|----|--|------|
| X202500 | 66 | Fender moulding (SS) (front lower) | pair |
| X203000 | 66 | Front fender moulding (except SS) | each |
| X203100 | 66 | Door moulding (2 door) (except SS) | each |
| X203200 | 66 | Rear quarter panel moulding (2 door) (except SS) | each |

68-72 SIDE MOULDINGS

| | | | |
|---------|-------|---------------------------------|------|
| X204100 | 68-72 | Fender moulding (left) | each |
| X204110 | 68-72 | Fender moulding (right) | each |
| X204120 | 68-72 | Door moulding (left) | each |
| X204130 | 68-72 | Door moulding (right) | each |
| X204140 | 68-72 | Quarter panel moulding | each |
| X204500 | 68-74 | Rocker panel mouldings | pair |
| X204515 | 68-72 | Door frame mouldings (set of 8) | set |

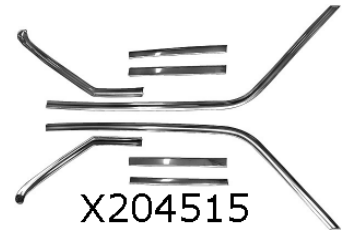

ROOF DRIP MOULDINGS

| | | | |
|---------|-------|----------------------------|------|
| X245000 | 62-65 | Roof drip mouldings (4 pc) | set |
| X245100 | 66-67 | Roof drip mouldings | pair |
| X245150 | 68-72 | Roof drip mouldings (6 pc) | set |
| X245160 | 73-74 | Roof drip mouldings (6 pc) | set |

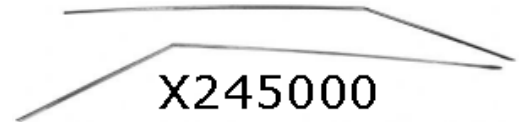

WINDSHIELD MOULDINGS

| | | | |
|---------|-------|------------------------------------|-----|
| X204800 | 62-67 | Windshield mouldings (4 pc)(HT) | set |
| X204850 | 62-67 | Windshield mouldings (4 pc)(sedan) | set |
| X205000 | 68-72 | Windshield mouldings | set |

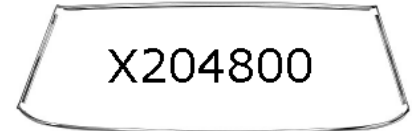

REAR WINDOW MOULDINGS

| | | | |
|---------|-------|------------------------------------|-----|
| X205050 | 62-65 | Rear window mouldings (HT) | set |
| X205100 | 66-67 | Rear window mouldings (HT) | set |
| X205200 | 68-74 | Rear window mouldings (all 2 door) | set |

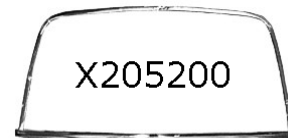

1962 – 1979 Nova & Acadian Catalogue Volume 9

PHONE: (905)627-4527 ORDERS 1-866-767-2787 FAX (905)627-3210

Exterior Mouldings, Chrome Parts & Trim

REAR QUARTER WINDOW CORNER MOULDINGS

X206600 66-67 Rear quarter window corner mouldings (HT) pair



X206600

OUTSIDE DOOR HANDLES

X206745 62-79 Door handles (outside, specify year) set
 X206755 62-79 Door handles (Taiwan)(outside, specify year)(includes buttons & gaskets) set
 X207500 62-75 Door handle buttons (included above) pair
 X316000 62-65 Door handle and lock gaskets set
 X316250 66-72 Door handle and lock gaskets set



X206755

RIMS

X269500A 69-70 SS rim (5 spoke)(14" x 7") each
 X269500B 69-70 SS rim (5 spoke)(14" x 8") each
 X269500C 69-70 SS rim (5 spoke)(15" x 7") each
 X269500D 69-70 SS rim (5 spoke)(15" x 8") each
 X269600A Nova rally rim (14" x 7") each
 X269600B Nova rally rim (14" x 8") each
 X269600C Nova rally rim (15" x 7") each
 X269600D Nova rally rim (15" x 8") each
 X269700A Camaro rally rim (14" x 6") each
 X269700B Camaro rally rim (14" x 7") each
 X269700C Camaro rally rim (14" x 8") each
 X269700D Camaro rally rim (15" x 7") each
 X269700E Camaro rally rim (15" x 8") each



X213220



X214250



X213750



X213230

WHEEL CAPS & RINGS

X213210 67 Rally wheel cap and ornament (repro) set
 ("Chevrolet Motor Division Disc Brakes")
 X213220 67 Rally wheel cap and ornament (repro) set
 ("Chevrolet Motor Division")
 X213230 67 Rally wheel cap (Police caps)(repro) set
 X213500 68-76 Rally wheel ornament (4 3/4" diameter) each
 X213750 69-70 "SS" wheel ornament (2 3/4" diameter) each
 X214100 68-76 Rally wheel cap and ornament (repro) set
 (with bowtie)
 X214150 68-76 Rally wheel cap and ornament (repro) set
 (1 1/2" shorter than GM)
 X214200 68-76 Rally wheel cap and ornament (repro) set
 (no emblem or letters)(chromed plastic)
 (perfect for Acadians!)(no lettering)
 X214250 68-76 Rally wheel center with ornament each
 X215000 69-70 Trim rings (SS, 14 x 7) set
 X215010 68-76 Trim rings (14 x 6) set
 X215020 68-76 Trim rings (15 x 7) set
 X215030 68-76 Trim rings (15 x 8)(rally wheels) set
 X215050 69-70 SS wheel nut (stainless clad) set

Note: You can mix & match trim rings. E.g. front 15x7 & rear 15x8 for the same price.



X215030

WHEEL EMBLEMS

X107000 63,65 Wheel cover insert "SS" each
 X107250 64 Wheel cover insert "SS" each
 X107300 67 Wheel cover insert "SS" each
 X107500 69-70 Wheel ornament insert "SS" set
 X107510 69-70 Wheel ornament inserts (SS 396) set
 X107520 69-70 Wheel ornament inserts (SS 454) set
 X107600 71 Wheel cover insert (finned style covers) each



X107250



X107500

1962 – 1979 Nova & Acadian Catalogue Volume 9

PHONE: (905)627-4527 ORDERS 1-866-767-2787 FAX (905)627-3210

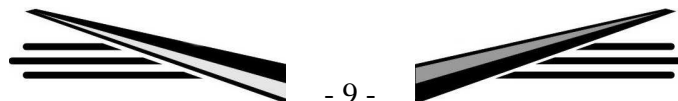

Exterior Mouldings, Chrome Parts & Trim



OUTSIDE DOOR MIRRORS

Note: All outside door mirrors come with mounting hardware.

| | | | |
|---------|-------|---|------|
| X216400 | 62 | Door mirror (with bowtie) | each |
| X216650 | 63-65 | Door mirror (with bowtie) | each |
| X216655 | 63-65 | Door mirror (without bowtie) | each |
| X216775 | 66-68 | Door mirror (without bowtie) | each |
| X216750 | 66-72 | Door mirror (with bowtie) | each |
| X613500 | 63-65 | Mirror mounting kit (gasket, bracket, and screws) | kit |
| X613750 | 66-72 | Mirror mounting kit (gasket, bracket, and screws) | kit |
| X410000 | 63-65 | Mirror gasket | each |



BUMPERS & RELATED

| | | | | | |
|----------|----------------|---|------|--|----------------|
| | |  | |  | |
| | X222500 | | | | X222560 |
| X222450 | 62-64 | Front bumper | each | | |
| X222460 | 65 | Front bumper | each | | |
| X222500 | 66-67 | Front bumper | each | | |
| X222550 | 68-69 | Front bumper | each | | |
| X222560 | 70-72 | Front bumper | each | | |
| X222565 | 62-65 | Rear bumper | each | | |
| X222570 | 66-67 | Rear bumper | each | | |
| X222580 | 68-72 | Rear bumper | each | | |
| X662300 | 62-65 | Front bumper brackets | pair | | |
| X662305 | 65 | Rear bumper brackets | PAIR | | |
| X662310 | 66-67 | Front bumper brackets | pair | | |
| X662320 | 66-67 | Rear bumper bracket (right) | each | | |
| X662325 | 66-67 | Rear bumper bracket (left) | each | | |
| X662350 | 68-72 | Front bumper bracket (left) | each | | |
| X662360 | 68-72 | Front bumper bracket (right) | each | | |
| X662400 | 68-72 | Rear bumper brackets | pair | | |
| X222800 | 62-72 | Bumper bolt kit (front & rear) | kit | | |
| X222810 | 62-72 | Bumper bolt with nut 7/16" x 1 1/4" (stainless cap)(flat) | each | | |
| X222810A | 62-72 | Bumper bolt with nut 7/16" x 1 1/4" (stainless cap)(domed) | each | | |
| X330000 | 68-72 | Bumper guard cushions (4 pc) | set | | |



ANTENNAS

| | | | |
|---------|-------|---------------------------------------|------|
| X224260 | 63-65 | Antenna nut | each |
| X224300 | 63-64 | Antenna assembly (left or right rear) | set |
| X224350 | | 15" co-ax cable for rear antennas | each |
| X224550 | 65-67 | Antenna mast (AM, original style) | each |
| X224760 | 66-69 | Antenna nut | each |
| X224800 | 68-69 | Antenna assembly (AM/FM) | each |
| X322000 | 66-67 | Front fender antenna gasket | each |



1962 – 1979 Nova & Acadian Catalogue Volume 9

PHONE: (905)627-4527 ORDERS 1-866-767-2787 FAX (905)627-3210

Exterior Mouldings, Chrome Parts & Trim

REAR PANEL MOULDINGS

The plastic rear panel moulding is made by Ted Williams Enterprises and he offers a Limited Lifetime Warranty. These are made with the same new type plastic and chrome plating process that is used on new vehicles today. **Note:** The 70-72 rear panel mouldings will fit the 68-69 Novas as well. Custom panels do not have emblem holes.



| | | | |
|---------|-------|--|------|
| X229960 | 68-69 | Rear panel moulding (SS)(plastic) | each |
| X229970 | 68-69 | Rear panel moulding (custom)(plastic) | each |
| X230010 | 70-72 | Rear panel moulding (SS)(die-cast) | each |
| X230015 | 70-72 | Rear panel moulding (custom)(die-cast) | each |
| X230020 | 70-72 | Rear panel moulding (SS)(plastic) | each |
| X230025 | 70-72 | Rear panel moulding (custom)(plastic) | each |



1962 – 1979 Nova & Acadian Catalogue Volume 9

PHONE: (905)627-4527 ORDERS 1-866-767-2787 FAX (905)627-3210



Weatherstrips, Gaskets & Rubber Parts

DOOR WEATHERSTRIPS

All of our door weatherstrips have the pins installed and moulded ends where original. Careful installation using our GM weatherstrip cement (see B309200) will give a superb fitting product.

| | | | |
|---------|-------|--|------|
| X300000 | 62-67 | Door weatherstrips (2 door sedan) | pair |
| X300250 | 62-67 | Door weatherstrips (HT/conv) | pair |
| X300350 | 62-67 | Door weatherstrips (front, 4 door sedan/wagon) | pair |
| X300500 | 62-67 | Door weatherstrips (rear, 4 door sedan) | pair |
| X300750 | 62-67 | Door weatherstrips (rear, 4 door wagon) | pair |
| X301000 | 68-74 | Door weatherstrips (2 door) | pair |
| X301250 | 68-74 | Door weatherstrips (front, 4 door) | pair |
| X301500 | 68-74 | Door weatherstrips (rear, 4 door) | pair |
| X301510 | 75-79 | Door weatherstrips (2 door) | pair |
| X301530 | 75-79 | Door weatherstrips (4 door, front) | pair |
| X301535 | 75-79 | Door weatherstrips (4 door, rear) | pair |



X300250



X301000

CONVERTIBLE TOP RUBBERS

| | | | |
|---------|-------|---------------------------------------|------|
| X301600 | 62-64 | Windshield pillar post seals (conv) | pair |
| X301700 | 62-63 | Convertible top weatherstrip (7 pcs.) | set |



ROOF RAIL WEATHERSTRIPS

| | | | |
|---------|-------|--------------------------------------|------|
| X301750 | 62-65 | Roofrail weatherstrips (2 door H.T.) | pair |
| X302250 | 66-67 | Roofrail weatherstrips (2 door H.T.) | pair |

WINDOWFELT KITS

We offer two kinds of windowfelts. Authentic and replacement styles.

Authentic style windowfelts are made from original materials from the manufacturers that made them for GM. Most feature a small rounded stainless bead and all have the rubbing blocks where needed.

Note: Please specify year and model when ordering.

| | | | |
|---------|-------|--|-----|
| X601760 | 62-65 | Windowfelt kit (2 door HT)(authentic) | kit |
| X601855 | 62-63 | Windowfelt kit (conv)(authentic) | kit |
| X602005 | 62-65 | Windowfelt kit (2 door sedan)(authentic) | kit |
| X602255 | 62-65 | Windowfelt kit (4 door sedan & wagon)(authentic) | kit |
| X602300 | 62-65 | Windowfelt kit (wagon tailgate)(authentic) | kit |
| X602600 | 66-67 | Windowfelt kit (2 door HT)(authentic) | kit |
| X602610 | 66-67 | Windowfelt kit (2 door HT)(outers)(authentic) | kit |
| X602800 | 66-67 | Windowfelt kit (2 door sedan)(authentic) | kit |
| X603050 | 66-67 | Windowfelt kit (4 door sedan)(authentic) | kit |
| X603100 | 66-67 | Windowfelt kit (wagon tailgate)(authentic) | kit |
| X603300 | 68-72 | Windowfelt kit (2 door)(authentic) | kit |
| X603305 | 68-72 | Windowfelt kit (2 door)(outers)(authentic) | kit |
| X603405 | 73-74 | Windowfelt kit (2 door)(authentic) | kit |
| X603410 | 75-79 | Windowfelt kit (2 door)(4 pc)(authentic) | kit |



Economy style windowfelts are very good replacements. They are made from a generic felt that features a flat strip of stainless. These are fine if cost is more important than originality.

Note: Please specify year and model when ordering.

| | | | |
|---------|-------|--|-----|
| X601750 | 62-65 | Windowfelt kit (2 door HT)(economy) | kit |
| X601850 | 62-63 | Windowfelt kit (conv)(economy) | kit |
| X602000 | 62-65 | Windowfelt kit (2 door sedan)(economy) | kit |
| X602250 | 62-65 | Windowfelt kit (4 door sedan & wagon)(economy) | kit |
| X602500 | 66-67 | Windowfelt kit (2 door HT)(economy) | kit |
| X602750 | 66-67 | Windowfelt kit (2 door sedan)(economy) | kit |

1962 – 1979 Nova & Acadian Catalogue Volume 9

PHONE: (905)627-4527 ORDERS 1-866-767-2787 FAX (905)627-3210

Weatherstrips, Gaskets & Rubber Parts

| | | | |
|---------|-------|----------------------------------|-----|
| X603250 | 68-72 | Windowfelt kit (2 door)(economy) | kit |
| X603350 | 68-72 | Windowfelt kit (4 door)(economy) | kit |
| X603400 | 73-74 | Windowfelt kit (2 door)(economy) | kit |



| | | | |
|---------|-------|--|-----|
| X603440 | 68-72 | Quarter glass channel kit (2 door)(both sides) | set |
|---------|-------|--|-----|

DOOR GLASS FELT LINERS

| | | | |
|----------|-------|---|------|
| BA605210 | 62-67 | Front division bar channels (HT/conv.) | pair |
| X603450 | 68-72 | Door glass felt liner (upper/rear)(2dr) (6' channel) | each |
| X603455 | 73-75 | Door glass felt liner (upper/rear)(2dr) (8' channel) | each |



TRUNK & TAILGATE WEATHERSTRIPS

| | | | |
|---------|-------|---|------|
| X302500 | 62-74 | Trunk weatherstrip | each |
| X302505 | 73-74 | Hatchback weatherstrips | each |
| X302550 | 62-67 | Wagon tailgate seal | each |
| X302600 | 75-79 | Trunk weatherstrip (slips over pinchweld) | each |



WEATHERSTRIP ADHESIVE

To do a superior job use the genuine GM black weatherstripping cement (not the yellow brand or silicon) between the pins to prevent "bridging" or "bulging" on hot days. One tube typically does one vehicle.

| | | | |
|---------|-----|---------------------|------|
| B309200 | all | Weatherstrip cement | each |
|---------|-----|---------------------|------|

FRONT WINDSHIELD SEALS

| | | | |
|---------|-------|-------------------------------------|------|
| X302750 | 62-67 | Front windshield seal (H.T./conv.) | each |
| X303000 | 62-67 | Front windshield seal (sedan/wagon) | each |

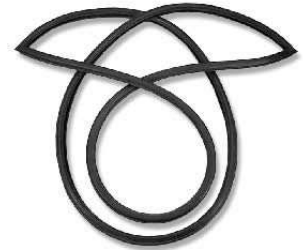

REAR WINDOW SEALS

| | | | |
|---------|-------|----------------------------|------|
| X303250 | 62-64 | Rear window seal (sedan) | each |
| X303500 | 62-65 | Rear window seal (hardtop) | each |

VENT WINDOW SEALS

| | | | |
|---------|-------|--|------|
| X303850 | 62-67 | Vent window seals (H.T.) (62-63 conv.) | pair |
| X303860 | 62-67 | Vent window seals (sedan) | pair |
| X303900 | 68-72 | Vent window seals (2 door) | pair |



QUARTER WINDOW SEALS

| | | | |
|---------|-------|-----------------------------------|------|
| X304000 | 62-65 | Quarter window seals (H.T./conv.) | pair |
| X304250 | 66-67 | Quarter window seals (H.T.) | pair |

QUARTER WINDOW DOOR JAMB "U" SEALS

| | | | |
|---------|-------|---|------|
| X304500 | 62-67 | Quarter window door jamb "U" seals (H.T./conv.) | pair |
|---------|-------|---|------|



HOOD TO COWL SEALS

| | | | |
|---------|-------|-------------------|------|
| X305000 | 62-67 | Hood to cowl seal | each |
| X305250 | 68-75 | Hood to cowl seal | each |

A-ARM SEALS

| | | | |
|---------|-------|-------------|------|
| X305750 | 68 | A-arm seals | pair |
| X306000 | 69-75 | A-arm seals | pair |



1962 - 1979 Nova & Acadian Catalogue Volume 9

PHONE: (905)627-4527 ORDERS 1-866-767-2787 FAX (905)627-3210

Weatherstrips, Gaskets & Rubber Parts

UNDER HOOD SEALS & GROMMETS

| | | | |
|---------|-------|-----------------------------------|------|
| X305500 | 62-67 | Cowl to fender shields | pair |
| X308000 | 62-65 | Main firewall wiring harness seal | each |
| X316750 | 62-72 | Windshield wiper motor grommets | set |



HEATER SEALS

| | | | |
|---------|-------|---------------------------------------|------|
| X308250 | 62-67 | Heater motor to firewall seals | pair |
| X308300 | 68-74 | Heater seal kit (small block)(no air) | kit |

PEDAL PADS & TRIM

| | | | |
|---------|-------|---|------|
| X308500 | 62-65 | Brake pad (with powerglide and power brakes) | each |
| X308750 | 62-67 | Brake pad (with powerglide, without power brakes) | each |
| X309000 | 62-67 | Brake and clutch pad (without powerglide and power brakes, vertical ribs) | each |
| X309250 | 62-67 | Brake and clutch pad (without powerglide and power brakes, horizontal ribs) | each |
| X309350 | 62-67 | Brake pad (with standard transmission and power brakes) | each |
| X309500 | 68-71 | Brake pad (with auto transmission and disc brakes, 6 1/2") | each |
| X309750 | 68-74 | Brake pad (with auto transmission, without disc brakes, 6 1/2") | each |
| X310000 | 68-72 | Brake pad (with standard transmission and disc brakes, 3 1/4") | each |
| X310250 | 68-79 | Brake and clutch pad without disc brakes, 3 1/4" | each |
| X310500 | 68 | Park brake pad | each |
| X310750 | 69-79 | Park brake pad | each |
| X406750 | 62-67 | Gas pedal | each |
| X407000 | 68-72 | Gas pedal | each |
| X407250 | 62-65 | Gas pedal bushing | each |
| X621500 | 62-67 | Gas pedal stud | each |
| X218000 | 68-72 | Gas pedal trim | each |
| X218250 | 68-72 | Brake pedal trim (with auto trans.) | each |
| X218500 | 68-70 | Brake and clutch pad trim | each |
| X218750 | 68 | Park brake pad trim | each |
| X219000 | 69-72 | Park brake pad trim | each |



X309000

X309250



X309750



X310750



X407000



X218000



X310800



X310900

STEERING COLUMN SEALS

| | | | |
|---------|-------|-------------------------------|------|
| X310800 | 62-67 | Steering column to floor seal | each |
| X310850 | 62-66 | Steering column seal sponge | each |
| X310900 | 67 | Steering column seal sponge | each |

LENS GASKETS

| | | | |
|---------|-------|---------------------------|------|
| X312500 | 62-64 | Park lamp lens gaskets | pair |
| X312750 | 65-67 | Park lamp lens gaskets | pair |
| X313000 | 68-69 | Park lamp lens gaskets | pair |
| X313250 | 71-72 | Park lamp lens gaskets | pair |
| X313500 | 62-64 | Tail lamp lens gaskets | pair |
| X313750 | 65-67 | Tail lamp lens gaskets | pair |
| X314250 | 68-69 | Tail lamp lens gaskets | pair |
| X314500 | 70 | Tail lamp lens gaskets | pair |
| X314750 | 71-72 | Tail lamp lens gaskets | pair |
| X314850 | 70-74 | Marker lamp bezel gaskets | set |
| X315000 | 62-64 | Tail lamp to body seals | set |
| X315250 | 66-67 | Tail lamp to body seals | pair |
| X315300 | 68-69 | Tail lamp bezel seals | pair |
| X315400 | 70-72 | Tail lamp bezel seals | pair |

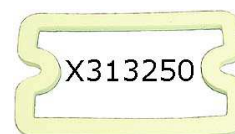

X313250



X314850

REAR BUMPER TO BODY SEALS

| | | | |
|---------|-------|--------------------------|------|
| X315750 | 62-65 | Rear bumper to body seal | each |
| X315900 | 68-72 | Rear bumper to body seal | each |



X315750

BODY TO FRAME CUSHIONS & HARDWARE

1962 – 1979 Nova & Acadian Catalogue Volume 9

PHONE: (905)627-4527 ORDERS 1-866-767-2787 FAX (905)627-3210



Weatherstrips, Gaskets & Rubber Parts

- X316500 68-76 Body to frame cushion set set
 X316510 68-76 Body to frame bolt kit kit



X614000



X614100



X316500

- X316550 68-76 Radiator support bushing & hardware set set
 X614100 68-72 Subframe mount repair kit set



X317750



X317800



X317850



X318000

BODY BUMPERS

- X317750 62-73 Front hood bumpers (round) pair
 X317755 74-79 Front hood bumper & stud (round) each
 X317760 62-73 Front hood adjuster bolt each
 X317800 62-65 Side hood bumpers (set of 4) set
 X317850 66-67 Side hood bumpers pair
 X318000 68-75 Side hood bumpers (requires 4) each
 X318250 62-66 Door bumpers (2 door, set of 4) set
 X318350 67 Door bumpers (2 door, set of 4) set
 X318500 68-74 Door bumper (lower) each
 X318550 68-74 Door bumper (upper) each
 X318750 62-79 Glove box bumpers pair
 X319000 62-75 Ash tray bumper each
 X319250 62-66 Seat back bumpers (round, for one seat) pair
 X319500 67-75 Seat back bumpers (oval, for one seat) pair
 X320000 62-74 Trunk lid bumpers pair
 X320010 62-75 License plate bumpers set
 X320100 62-79 Brake and clutch pedal stop each
 X320250 62-65 Body bumper kit (doors, hood, trunk, and kit glove box)
 X320500 66 Body bumper kit (doors, hood, trunk, and kit glove box)
 X320750 67 Body bumper kit (doors, hood, trunk, and kit glove box)
 X321000 68-74 Body bumper kit (doors, hood, trunk, and kit glove box)



X318250

X318500



X318750



X320000



X319500



PAINT GASKET KITS

Paint gasket kits include such items as door handle & lock gaskets, tail and park lamp lens gaskets, market lamp gaskets, and other gaskets relevant to the year. These do not include bezel to body gaskets.

- X322450 62-72 Paint gasket set (specify year) set



X322450
(specify year)

1962 – 1979 Nova & Acadian Catalogue Volume 9

PHONE: (905)627-4527 ORDERS 1-866-767-2787 FAX (905)627-3210



Lights, Lenses & Related

PARK LAMP LENSES

| | | | |
|---------|-------|---|------|
| X400000 | 62-64 | Park lamp lenses (clear)(62 Nova, 62-64 Acadians) | pair |
| X400010 | 63-64 | Park lamp lenses (amber)(Nova only) | pair |
| X400050 | 65 | Park lamp lens | pair |
| X400060 | 66-67 | Park lamp lenses (specify clear or amber) | pair |
| X400070 | 68-69 | Park lamp lenses (amber) | pair |
| X400080 | 70 | Park lamp lenses (clear) | pair |
| X400090 | 71-72 | Park lamp lenses (amber) | pair |



X400010



X400080

PARK LAMP ASSEMBLIES

| | | | |
|---------|-------|---|------|
| X514000 | 62 | Park lamp assembly (left)(clear lens) | each |
| X514010 | 62 | Park lamp assembly (right)(clear lens) | each |
| X514020 | 63-64 | Park lamp assembly (left)(amber lens) | each |
| X514030 | 63-64 | Park lamp assembly (right)(amber lens) | each |
| X514100 | 65 | Park lamp assembly (left) | each |
| X514110 | 65 | Park lamp assembly (right) | each |
| X514120 | 66-67 | Park lamp assembly (left) | each |
| X514130 | 66-67 | Park lamp assembly (right) | each |
| X514140 | 68-69 | Park lamp assembly (left or right) (clear lens) | each |
| X514190 | 70 | Park lamp assembly (left or right) (clear lens) | each |
| X514200 | 71-72 | Park lamp assembly (left or right) (amber lens) | each |



X514130

X514140

TAIL LAMP LENSES

| | | | |
|---------|-------|--|------|
| X400800 | 62-64 | Tail, backup, and reflector lens set (does 1 side) | set |
| X400850 | 65 | Tail lamp lenses | pair |
| X400900 | 66-67 | Tail lamp lenses (with "Guide") | pair |
| X400910 | 66-67 | Tail lamp lenses (without "Guide") | pair |
| X401000 | 68-69 | Tail lamp lenses (with "Guide") | pair |
| X401100 | 70-71 | Tail lamp lens (left)(with "Guide") | each |
| X401105 | 70-71 | Tail lamp lens (right)(with "Guide") | each |
| X401110 | 70-71 | Tail lamp lenses (without "Guide") | pair |
| X401150 | 72 | Tail lamp lens (left)(with "Guide") | each |
| X401155 | 72 | Tail lamp lens (right)(with "Guide") | each |
| X401160 | 72 | Tail lamp lenses (without "Guide") | pair |



X400800

X400900



X401110

TAIL LAMP ASSEMBLIES

| | | | |
|---------|-------|---|------|
| X515200 | 62-64 | Tail lamp assembly | each |
| X515300 | 66-67 | Tail lamp assembly (bright aluminum housing, lens, lens gaskets, body gasket, screws)(Taiwan made) | each |
| X515350 | 66-67 | Tail lamp assembly (bright aluminum housing, body gasket, "Guide" lenses, gaskets, screws)(US Made) | each |
| X515400 | 68-69 | Tail lamp assembly (left) | each |
| X515415 | 68-69 | Tail lamp assembly (right) | each |
| X515500 | 70-71 | Tail lamp assembly (left) | each |
| X515510 | 70-71 | Tail lamp assembly (right) | each |
| X515520 | 72 | Tail lamp assembly (left) | each |
| X515530 | 72 | Tail lamp assembly (right) | each |



X515300



X515530

BACK-UP LAMP LENSES

| | | | |
|---------|-------|--|------|
| X400800 | 62-64 | Tail, backup, and reflector lens set (does 1 side) | set |
| X401750 | 65 | Back-up lenses | pair |
| X401800 | 66-67 | Back-up lenses (with "Guide") | pair |
| X401805 | 66-67 | Back-up lenses (red) | pair |
| X401810 | 66-67 | Back-up lenses (without "Guide") | pair |
| X401850 | 68-69 | Back-up lenses | pair |

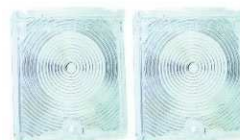

X401800

1962 – 1979 Nova & Acadian Catalogue Volume 9

PHONE: (905)627-4527 ORDERS 1-866-767-2787 FAX (905)627-3210

Lights, Lenses & Related

LICENSE LAMP LENSES

| | | | |
|---------|-------|-----------------------|------|
| X401890 | 62-65 | License lamp lens | each |
| X402000 | 66-72 | License lamp lens | each |
| X510700 | 62-65 | License lamp assembly | EACH |
| X510750 | 66-72 | License lamp assembly | each |



X510750

MARKER LAMP ASSEMBLIES

| | | | |
|---------|----|------------------------------------|------|
| X403000 | 68 | Front marker lamp assembly (amber) | each |
| X403100 | 69 | Front marker lamp assembly (clear) | each |



X403000



X403100



X403200

| | | | |
|---------|-------|---------------------------------|------|
| X403200 | 68-69 | Rear marker lamp assembly (red) | each |
| X403500 | 70-74 | Front marker lamp assemblies | pair |
| X403550 | 70-72 | Rear marker lamp assemblies | pair |



X403550

MARKER LAMP BEZELS

| | | | |
|---------|-------|---|------|
| X108250 | 68-69 | Marker lamp bezels (307) | pair |
| X108500 | 68-69 | Marker lamp bezels (327) | pair |
| X108750 | 68-69 | Marker lamp bezels (350) | pair |
| X109000 | 68-69 | Marker lamp bezels (396) | pair |
| X109250 | 68-69 | Marker lamp bezels (427) | pair |
| X109500 | 68-69 | Marker lamp bezel (6cyl. front, all rear) | each |
| X109510 | 70-75 | Marker lamp bezel (front) | each |
| X109520 | 70-79 | Marker lamp bezel (70-75 rear)(76-79 front or rear) | each |
| X314850 | 70-74 | Marker lamp bezel gaskets | set |



X108250



X109510

HEADLAMP ADJUSTER KITS

| | | | |
|---------|-------|---------------------------------|------|
| X696600 | 62-64 | Headlamp adjuster kit (2 lamps) | kit |
| X696610 | 65-79 | Headlamp adjuster kit (2 lamps) | kit |
| X696620 | 62-74 | Headlamp adjusting spring | each |



1962 – 1979 Nova & Acadian Catalogue Volume 9

PHONE: (905)627-4527 ORDERS 1-866-767-2787 FAX (905)627-3210

Switches & Harnesses

HEADLAMP SWITCHES

| | | | |
|---------|-------|---------------------------|------|
| X500000 | 62-63 | Headlamp switch | each |
| X500250 | 64-73 | Headlamp switch | each |
| X500300 | 74-84 | Headlamp switch | each |
| X409090 | 67-68 | Light switch knob & shaft | each |
| X409190 | 69-70 | Light switch knob & shaft | each |
| X409195 | 72-75 | Light switch knob & shaft | each |
| X500500 | 62-75 | Dimmer switch | each |



X500250

IGNITION SWITCHES & RELATED

| | | | |
|---------|-------|--|------|
| X501000 | 62-64 | Ignition switch | each |
| X501100 | 62-64 | Ignition switch indicator | each |
| X501250 | 65 | Ignition switch | each |
| X501500 | 66-67 | Ignition switch | each |
| X501750 | 68 | Ignition switch | each |
| X502000 | 69-75 | Ignition switch (without tilt) | each |
| X614900 | 62-64 | Ignition cylinder (with original keys) | each |
| X614910 | 65 | Ignition cylinder (with original keys) | each |
| X614915 | 66-67 | Ignition cylinder (with original keys) | each |
| X614990 | 62-67 | Ignition cylinder (w/keys, specify yr) | each |
| X615060 | 68 | Ignition cylinder (with keys) | each |
| X615070 | 68 | Ignition cylinder (with original keys) | each |
| X615090 | 69-78 | Ignition cylinder (with keys) | each |



X501250



X614900



X502250



X502500

DOOR JAMB SWITCHES

| | | | |
|---------|-------|-----------------------------|------|
| X502250 | 63-67 | Door jamb switch (one wire) | each |
| X502500 | 68-79 | Door jamb switch (two wire) | each |

HEATER CONTROL

| | | | |
|---------|-------|--|------|
| X505000 | 69-74 | Heater switch (fan control, with air conditioning) | each |
| X505050 | 69-79 | Heater fan switch (without air) | each |
| X505055 | 69-74 | Heater blower switch (with air)(under hood) | EA |
| X505060 | 69-74 | Heater control assembly (without air) (with cables, faceplate switch & levers) | EA |
| X505065 | 69-74 | Heater control assembly (with air) (with cables, faceplate switch & levers) | EA |
| X505080 | 69-74 | Heater cables (without air)(set/3) | SET |
| X505085 | 69-74 | Heater cables (with air)(set/3) | EA |
| X505095 | 17 | Heater control face lens (with air) | EA |



X505200

POWER WINDOW SWITCHES

| | | | |
|---------|-------|--------------------------------|------|
| X505200 | 64-70 | Power window switch (4 button) | each |
| X505230 | 64-70 | Power window switch (1 button) | each |
| X505260 | 71-75 | Power window switch (4 button) | each |
| X505270 | 71-75 | Power window switch (1 button) | each |

BACKUP & NEUTRAL SAFETY SWITCHES

| | | | |
|---------|-------|---|------|
| X505300 | 62 | Backup lamp switch (4 speed manual) | each |
| X505310 | 63 | Backup lamp switch (4 speed manual) | each |
| X505320 | 64 | Backup lamp switch (4 speed manual) | each |
| X505330 | 65-67 | Backup lamp switch (4 speed manual) | each |
| X505340 | 68 | Backup lamp switch (4 speed manual) | each |
| X505350 | 64-68 | Backup lamp switch mounting kit (4 speed Muncies) | each |
| X505500 | 63-66 | Neutral safety and back-up switch (with auto transmission, column switch) | each |
| X505600 | 65-67 | Neutral safety switch (auto, console) | each |
| X505700 | 69-72 | Neutral safety & backup switch (column, automatic) | each |



X505310



X505600

1962 – 1979 Nova & Acadian Catalogue Volume 9

PHONE: (905)627-4527 ORDERS 1-866-767-2787 FAX (905)627-3210



Switches & Harnesses

HORNS & RELAYS

| | | | |
|----------|-------|------------------|------|
| X511500 | 62 | Horn relay | each |
| X511750 | 63-65 | Horn relay | each |
| X512000 | 66-71 | Horn relay | each |
| X509220 | 74-79 | Horn relay | each |
| X512005H | 62-79 | Horn (high note) | each |
| X512005L | 62-79 | Horn (low note) | each |

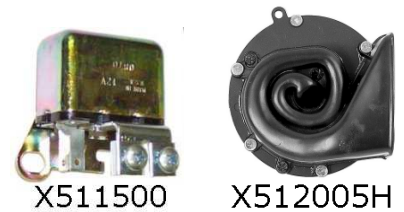

STEERING COLUMN BEARING

| | | | |
|---------|----|---|------|
| X512500 | 63 | Steering column upper bearing and horn wire (fits 64) | each |
|---------|----|---|------|



TURN SIGNAL SWITCHES & RELATED

| | | | |
|---------|----|----------------------------------|------|
| X506500 | 62 | Turn signal switch | each |
| X506510 | 62 | Turn signal mechanism repair kit | kit |



X507000



X507500



X507600



X506500



X506510

| | | | |
|---------|-------|---|------|
| X506515 | 62 | Turn signal mechanism pivot bolt | each |
| X506750 | 63-64 | Turn signal switch (first design) | each |
| X507000 | 64-65 | Turn signal switch (second design 64, stamped "SAE Q 64") | each |
| X507500 | 66 | Turn signal switch (BPC metal type) | each |
| X507600 | 66 | Turn signal switch ("Guide" plastic type) | each |
| X507750 | 67-68 | Turn signal switch (Boyne brand)(8 peg) | each |
| X508000 | 67-68 | Turn signal switch (Delco brand)(9 peg) | each |
| X508250 | 69-76 | Turn signal switch | each |
| X409770 | 62-65 | Turn signal canceling cam (except tilt) | each |
| X409775 | 63-64 | Turn signal canceling plate (1st design) | each |
| X409780 | 64-65 | Turn signal canceling plate (2nd design) | each |
| X409790 | 66 | Turn signal canceling plate | each |



X507750



X508000

BRAKE LAMP SWITCH

| | | | |
|---------|-------|------------------------------------|------|
| X508500 | 62-75 | Brake lamp switch (without cruise) | each |
|---------|-------|------------------------------------|------|



X508500



X505000

PRINTED CIRCUIT

| | | | |
|---------|-------|-----------------|------|
| X515000 | 68-72 | Printed circuit | each |
|---------|-------|-----------------|------|

FACTORY FIT WIRING HARNESSSES



M. Parker Autoworks Inc. (a.k.a. Factory Fit or American Auto Wire) has been manufacturing quality wiring harnesses for General Motors vehicles from 1955 to 1982 for nearly 20 years. The Factory Fit® line of wiring harnesses is widely known as the symbol of excellence in after market wiring components. **Note:** When ordering, please give as much information on your vehicle as possible, such as transmission, dash characteristics, model, accessories etc...

| | | | |
|---------|-------|---|------|
| X520000 | 62-67 | Air conditioning harness | each |
| X520015 | 68-74 | Air conditioning harness | each |
| X520080 | 64 | Backup light harness (rear body harness connection to taillights) | each |
| X520100 | 64-67 | Backup light jumper harness | each |

1962 – 1979 Nova & Acadian Catalogue Volume 9

PHONE: (905)627-4527 ORDERS 1-866-767-2787 FAX (905)627-3210

Switches & Harnesses

| | | | |
|---------|-------|---|------|
| X520110 | 68 | Backup light switch extension (manual) | each |
| X520200 | 64 | Clock harness (Dash mounted) | each |
| X520210 | 68-72 | Clock harness (Dash mounted) | each |
| X520250 | 63-64 | Console courtesy lamp harness | each |
| X520260 | 65-67 | Console harness (W/AT) | each |
| X520270 | 68-76 | Console gauge harness (factory gauges) | each |
| X520300 | 62-63 | Courtesy light harness (conv) | each |
| X520390 | 62-67 | Dash harness (Specify) | each |
| X520455 | 68-69 | Dash harness (Specify) | each |
| X520489 | 70-71 | Dash harness (Specify) | each |
| X520509 | 72-74 | Dash harness (Specify) | each |
| X520990 | 62-67 | Engine harness (Specify) | each |
| X521029 | 68-69 | Engine harness (Specify) | each |
| X521059 | 70-71 | Engine harness (Specify) | each |
| X521089 | 72-74 | Engine harness (Specify) | each |
| X521120 | 75 | Engine harness (All V-8) | each |
| X521499 | 62-67 | Front light harness (Specify) | each |
| X521509 | 63-72 | Alternator conversion harness (external to internal regulator) | each |
| X521529 | 68-69 | Front light harness (Specify) | each |
| X521559 | 70-74 | Front light harness (Specify) | each |
| X521700 | 62 | Rear body light harness (conv) | each |
| X521705 | 62 | Rear body light harness (HT) | each |
| X521710 | 63 | Rear body light harness (conv) | each |
| X521715 | 63-64 | Rear body light harness (HT) | each |
| X521720 | 65 | Rear body light harness | each |
| X521725 | 66-67 | Rear body light harness | each |
| X521730 | 68 | Rear body light harness | each |
| X521735 | 68 | Rear body light harness (with courtesy lamps) | each |
| X521740 | 69 | Rear body light harness (left) | each |
| X521745 | 69 | Rear body light harness (left)(with courtesy lamps) | each |
| X521750 | 69-71 | Rear body light harness (right) | each |
| X521760 | 70-72 | Rear body light harness (left) | each |
| X521765 | 70-72 | Rear body light harness (left)(with courtesy lamps) | each |
| X521770 | 72 | Rear body light harness (left)(with seat belt warning) | each |
| X521775 | 72 | Rear body light harness (left)(with courtesy lights & seat belt warning) | each |
| X521780 | 72 | Rear body light harness (right) | each |
| X521790 | 73 | Rear body light harness (front) | each |
| X521792 | 73 | Rear body light harness (front)(with courtesy lamps) | each |
| X521795 | 73 | Rear body light harness (rear) | each |
| X521820 | 74 | Rear body light harness (rear) | each |
| X522010 | 65-66 | Dome light harness (w/sep conn) | each |
| X522020 | 65-67 | Dome light harness (plugs in rr) | each |
| X522040 | 69-72 | Defogger harness (rear window) | each |
| X522050 | 73-75 | Fuel tank sending unit harness | each |
| X522070 | 64-67 | Ground wire (A/C comp,6 Cyl) | each |
| X522080 | 64-67 | Ground wire (A/C comp,V-8) | each |
| X522090 | 68-72 | Ground wire (A/C compressor) | each |
| X522100 | 62-65 | Heater harness | each |
| X522110 | 70 | Idle stop solenoid wire (V-8) | each |
| X522120 | 68-69 | Kickdown harness (TH400 A/T) | each |
| X522130 | 72 | Kickdown harness (TH400 A/T) | each |
| X522149 | 62-72 | Power lead wire (specify) | each |
| X522200 | 67 | Speed warning harness | each |
| X522210 | 69 | Speed warning harness | each |
| X522260 | 63 | Wiper harness (2 speed wiper) | each |

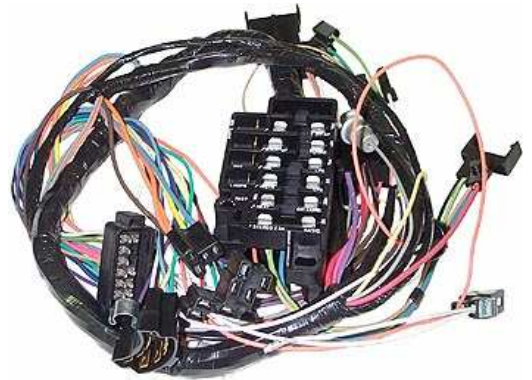

1962 – 1979 Nova & Acadian Catalogue Volume 9

PHONE: (905)627-4527 ORDERS 1-866-767-2787 FAX (905)627-3210





The **Classic Update Kit** is a complete wiring system that allows for the addition of modern conveniences in yesterday's vehicles - without compromising wiring appearance or integrity. There are no other kits on the market that compare to the depth of features and ease of installation that the Classic Update Kit offers. All **Classic Update Kits** were built around, and in conjunction with, other industry leaders so our kits accept the connections of many top name aftermarket manufacturer's products such as, Autometer, Classic Instruments, Dakota Digital, Flaming River, Hot Rod Air, Ididit, Stewart Warner, Vintage Air, and VDO. **Classic Update Kits** are engineered specifically for the exact requirements of the vehicle. **Note:** Other years are currently in development as we speak!

X500878 69-72 Classic update kit

kit

69-72 Chevy Nova

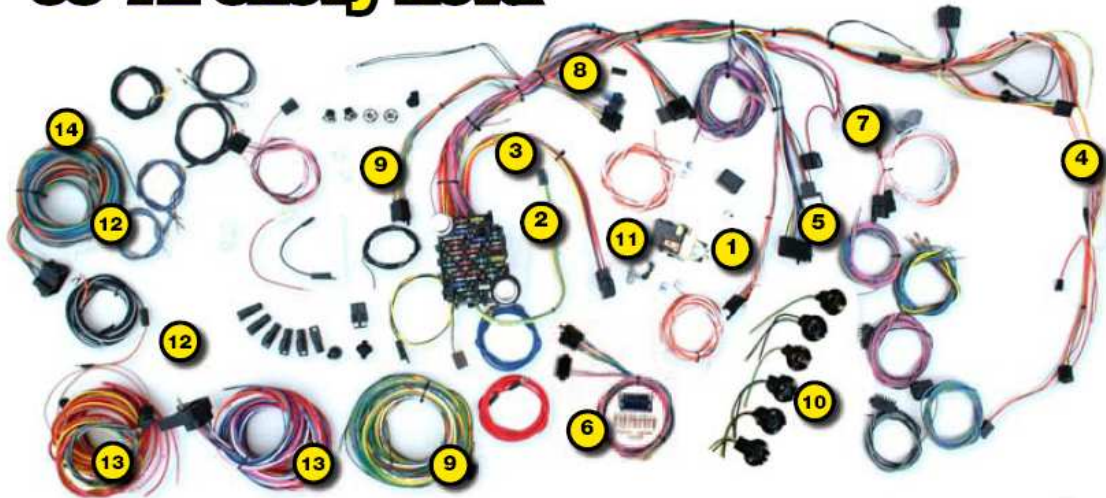

- 1** Replacement headlight switch with internal 30 amp circuit breaker included. Retention collar nut, adjustable length shaft, and custom knob are also included.
- 2** Standard turn signal flasher, hazard flasher, and horn relay mounted on fuse panel.
- 3** Fuse box designed to fit in original location. All required hardware supplied. New ATO fuse allow easy fuse and circuit breaker accessibility. Harness is laid out and formed to allow for nearly all after market accessories such as; gauge packages, wiper systems, heat and air conditioning systems, etc.
- 4** Original switch connector bodies! (Exclusive to American Autowire)
- 5** Steering column connectors will plug directly into most after market steering columns as well as 1969 and later GM columns which utilize stock GM turn signal switches. The original column can also be wired by using the supplied mating connector and terminals.
- 6** Original Dash Panel instrument Cluster Connector.
- 7** Along with wiring for your original dome/interior lighting we have included separate under-dash light sockets.
- 8** Instrument Cluster wiring is designed with a "cluster harness disconnect" system for easy service and assembly. All original terminals, connectors (exclusively from American Autowire), and light sockets are also supplied for original cluster gauges. However, the best aspect of the disconnect system is that any gauge cluster package can be easily and neatly wired in. This includes AUTOMETER, CLASSIC INSTRUMENTS, COVAN CLASSICS, DAKOTA DIGITAL, STEWART WARNER, and VDO just to name a few.
- 9** Rear body harness assembly is designed to plug into the main harness in the original connector bodies. Flexibility in harness design allows for original or custom routing. Rear body wiring includes backup light wires and mating connectors for backup light leads. License plate lead, connectors, and terminals included. Fuel tank sender wire and terminal included.
- 10** EXCLUSIVE! You'll find all the original style light socket pigtailed into every aspect of this system making it the most complete system of it's type in the industry!
- 11** New floor dimmer switch is provided. Wire length and connection accommodate original floor mount dimmer switch.
- 12** Original bulkhead connector for the engine and front light wiring is included and ready for installation. Original routing of the new harness without any body modifications!
- 13** Engine wiring includes connectors for original points type as well as H.E.I. distributors. Power and tach connectors supplied for GM H.E.I. distributors. Alternator connectors are supplied for GM "SI" series internally regulated alternators. GM "CS" series alternator adapter is available separately.
- 14** Front lighting includes extra long leads for special routing when custom under hood appearance is desired. All headlight, park light and directional light connectors and terminals are provided, as well as a switched trigger wire for electric fan relay (usually recommended with AC).

1962 – 1979 Nova & Acadian Catalogue Volume 9

PHONE: (905)627-4527 ORDERS 1-866-767-2787 FAX (905)627-3210

Underhood & Drivetrain Parts

BATTERY TRAYS & RELATED

| | | | |
|---------|-------|---|------|
| X600000 | 62-67 | Battery tray | each |
| X600100 | 62-67 | Battery retainer (V8)(across top) | each |
| X600250 | 68-72 | Battery retainer (62-67 6 cyl, 68-79 all) | each |
| X600500 | 68-74 | Battery tray | each |
| X600600 | 75-79 | Battery tray | each |
| X600750 | 62-72 | Battery retainer bolt (exc. 62-67 V-8) | each |
| X600850 | 62-67 | Battery retainer bolt (V-8, takes 2) | each |
| X600900 | 62-72 | Battery cable (specify year, engine, a/c, positive or negative) | each |



HOOD INSULATION PADS & CLIPS

| | | | |
|---------|-------|-------------------------------|------|
| X601000 | 62-65 | Hood insulation pads | set |
| X601250 | 66-67 | Hood insulation pads | set |
| X601500 | 68-74 | Hood insulation pads | set |
| X422000 | 65-75 | Hood insulation clip (round) | each |
| X422100 | 65-75 | Hood insulation clip (square) | each |



AIR CLEANERS

| | | | |
|---------|-------|---|------|
| X697940 | 64 | Air cleaner assembly (283 & 327 4BBL) (oval snorkel) | each |
| X697950 | 64-65 | Air cleaner assembly (283 & 327 4BBL) (tapered round snorkel) | each |
| X698000 | 64-67 | L79 air cleaner assembly (includes element and flame arrestor) | each |
| X698010 | 66-67 | Small block 4BBL air cleaner (includes air cleaner element) | each |
| X698020 | 66-69 | 350, 360 & 375 hp big block air cleaner (includes element and flame arrestor) | each |
| X698025 | 66-69 | 350, 360 & 375 hp big block air cleaner (chrome lid included) | each |



HOOD HINGES & SPRINGS

| | | | |
|---------|-------|--------------------|------|
| X610090 | 63-65 | Hood hinge (left) | each |
| X610095 | 63-65 | Hood hinge (right) | each |
| X610100 | 66-67 | Hood hinge (left) | each |
| X610110 | 66-67 | Hood hinge (right) | each |
| X610600 | 68-79 | Hood hinge (left) | each |
| X610650 | 68-79 | Hood hinge (right) | each |
| X611250 | 63-64 | Hood spring | each |
| X611500 | 65 | Hood spring | each |
| X611750 | 66-79 | Hood spring | each |



| | | | |
|---------|-------|--|------|
| X617500 | 62-70 | Trunk latch | each |
| X617600 | 71-74 | Trunk latch | EACH |
| X618800 | 68-72 | Transmission shifter stablizer rod and bushing (4-Speed) | each |



1962 – 1979 Nova & Acadian Catalogue Volume 9

PHONE: (905)627-4527 ORDERS 1-866-767-2787 FAX (905)627-3210



Underhood & Drivetrain Parts

CLUTCH PARTS

| | | | |
|---------|-------|---|-----|
| X618900 | 68-72 | Clutch linkage set (big block) | set |
| X618850 | 68-72 | Clutch linkage set, 6 cyl & small block | SET |



X619250

| | | | |
|---------|-------|---|------|
| X619250 | 68-72 | Clutch push rod assembly (lower, SB) | each |
| X619500 | 68-72 | Clutch spring extension rod (SB) | each |
| X317500 | 68-72 | Clutch rod boot | each |
| X317550 | 64-69 | Clutch fork boot | each |
| X619900 | 62-67 | Clutch cross shaft (Z bar) | each |
| X619750 | 68-72 | Clutch cross shaft (Z bar)(6 cyl & SB) | each |
| X619800 | 68-72 | Clutch cross shaft (Z bar)(big block) | EACH |
| X619910 | 62-67 | Clutch release fork | each |
| X619915 | 68-72 | Clutch release fork | EACH |
| X620000 | 62-79 | Clutch pivot ball (block side) | each |
| X620250 | 62-72 | Clutch pivot ball (frame side) (included with Z-bar) | each |
| X620300 | 62-67 | Clutch pivot ball bracket (block) | each |
| X620310 | 62-67 | Clutch pivot ball bracket (frame side) | each |
| X620350 | 68-72 | Clutch pivot ball bracket (frame side) | each |
| X620500 | 68-72 | Clutch fork return spring (small block) | each |
| X620510 | 68-72 | Clutch fork return spring (big block) | each |
| X620550 | 62-72 | Z-bar repair kit (includes pivot balls, felts & seats) | kit |
| X620600 | 62-65 | Brake and clutch pedal assembly | each |
| X620650 | 66-67 | Brake and clutch pedal assembly | each |
| X620750 | 68-72 | Brake and clutch pedal assembly | each |



X317550



X317410



X620310



X620750



X620300

GAS TANKS & RELATED

| | | | |
|---------|-------|---|------|
| X621130 | 62-65 | Gas tank gauge (5/16" except 4 BBL) | each |
| X621140 | 62-65 | Gas tank gauge (3/8" line) | each |
| X621145 | 66-67 | Gas tank gauge (5/16" line) | each |
| X621147 | 66-67 | Gas tank gauge (3/8" with 4 BBL) | each |
| X621150 | 68-70 | Gas tank gauge (6 cylinder) | each |
| X621160 | 68-72 | Gas tank gauge (327, 350, Special High-Performance 396)(3/8" line) | each |



X621130



X621160



| | | | |
|-----------------|--------------|--|-------------|
| X621190 | 62-67 | Gas tank strap | each |
| X621200 | 68-72 | Gas tank strap | each |
| X621250 | 62-64 | Gas cap (chrome) | each |
| X621250B | 62-64 | Gas cap (black) | each |
| X621255 | 65-67 | Gas cap (chrome) | each |
| X621255B | 65-67 | Gas cap (black) | each |
| X608950 | 68-69 | Gas cap, for original tanks | EACH |
| X609000 | 70-74 | Gas cap, vented, w/out emission control | each |
| X621300 | 62-67 | Gas tank | each |
| X621350 | 68-69 | Gas tank | each |
| X621400 | 70-72 | Gas tank (with filler neck, without vent pipes) | each |
| X621410 | 70-72 | Gas tank (with filler neck & vent pipes) | each |
| X621500 | 62-67 | Gas pedal stud | each |
| X621600 | 68-72 | Gas door (with hinge & spring) | each |
| X315500 | 62-67 | Gas tank filler tube to body seal | each |
| X315550 | 62-79 | Gas tank "O" ring | each |



X621255



X621300



X621600

1962 – 1979 Nova & Acadian Catalogue Volume 9

PHONE: (905)627-4527 ORDERS 1-866-767-2787 FAX (905)627-3210



Underhood & Drivetrain Parts

FRONT BRAKE LINES

In order to bring in the proper lines for your particular vehicle, please specify year and model, drums or discs, power or manual brakes.

| | | | |
|---------|-------|---|-----|
| X626990 | 62-66 | Front brake lines (steel)(specify) | set |
| X626995 | 62-66 | Front brake lines (stainless)(specify) | set |
| X627060 | 67 | Front brake lines (steel) | set |
| X627061 | 67 | Front brake lines (stainless) | set |
| X627080 | 68-78 | Front brake lines (steel)(except 70 with power disc)(specify) | set |
| X627090 | 68-78 | Front brake lines (stainless)(except 70 with power disc)(specify) | set |
| X627170 | 70 | Front brake lines (power disc)(steel) | set |
| X627180 | 70 | Front brake lines (power disc)(stainless) | set |

FRONT TO REAR BRAKE LINES

In order to bring in the proper lines for your particular vehicle, please specify year and model, drums or discs, power or manual brakes.

| | | | |
|---------|-------|--------------------------------------|------|
| X627300 | 62-68 | Front to rear brake line (steel) | each |
| X627310 | 62-68 | Front to rear brake line (stainless) | each |
| X627400 | 69-78 | Front to rear brake line (steel) | each |
| X627410 | 69-78 | Front to rear brake line (stainless) | each |

REAR AXLE BRAKE LINES

In order to bring in the proper lines for your particular vehicle, please specify year and model, drums or discs, power or manual brakes.

| | | | |
|---------|-------|-----------------------------------|------|
| X627600 | 62-65 | Rear axle brake lines (steel) | pair |
| X627610 | 62-65 | Rear axle brake lines (stainless) | pair |

FUEL PUMP TO CARB LINES

| | | | |
|---------|-------|--|-----|
| X628000 | 63-65 | Fuel pump to carburetor lines (6 cyl.) (steel) | set |
| X628005 | 63-65 | Fuel pump to carburetor lines (6 cyl.) (stainless) | set |
| X628010 | 65-67 | Fuel pump to carburetor lines (283 2BBL) (steel) | set |
| X628015 | 65-67 | Fuel pump to carburetor lines (283 2BBL) (stainless) | set |
| X628020 | 65 | Fuel pump to carburetor lines (327 - 350hp with L-74 option)(steel) | set |
| X628025 | 65 | Fuel pump to carburetor lines (327 - 350hp with L-74 option)(stainless) | set |
| X628040 | 66 | Fuel pump to carburetor lines (327 - 275hp, carter, enters at rear)(steel) | set |
| X628045 | 66 | Fuel pump to carburetor lines (327 - 275hp, carter, enters at rear)(stainless) | set |
| X628048 | 66-67 | Fuel pump to carburetor lines (L-79) (chrome) | set |
| X628050 | 67 | Fuel pump to carburetor lines (327 - 210hp 2BBL)(before 4-1-67)(steel) | set |
| X628055 | 67 | Fuel pump to carburetor lines (327 - 210hp 2BBL)(before 4-1-67)(stainless) | set |
| X628060 | 67-68 | Fuel pump to carburetor lines (230ci) (steel) | set |
| X628065 | 67-68 | Fuel pump to carburetor lines (230ci) (stainless) | set |
| X628070 | 67-68 | Fuel pump to carburetor lines (327 - 210hp 2BBL)(after 4-1-67)(steel) | set |
| X628075 | 67-68 | Fuel pump to carburetor lines (327 - 210hp 2BBL)(after 4-1-67)(stainless) | set |
| X628080 | 67-68 | Fuel pump to carburetor lines (327 - 275hp & 350 - 295hp 4BBL)(steel) (specify 5/16" or 3/8" line) | set |



1962 – 1979 Nova & Acadian Catalogue Volume 9

PHONE: (905)627-4527 ORDERS 1-866-767-2787 FAX (905)627-3210



Underhood & Drivetrain Parts

| | | | |
|---------|-------|--|-----|
| X628085 | 67-68 | Fuel pump to carburetor lines (327 - 275hp & 350 - 295hp 4BBL)(stainless) (specify 5/16" or 3/8" line) | set |
| X628090 | 67-68 | Fuel pump to carburetor lines (396 - 325hp & 350hp)(steel) | set |
| X628095 | 67-68 | Fuel pump to carburetor lines (396 - 325hp & 350hp)(stainless) | set |
| X628100 | 68 | Fuel pump to carburetor lines (396 - 375hp Holley)(three lines with block) (steel) | set |
| X628105 | 68 | Fuel pump to carburetor lines (396 - 375hp Holley)(three lines with block) (stainless) | set |
| X628110 | 68-70 | Fuel pump to carburetor lines (6 cyl.) (steel) | set |
| X628115 | 68-70 | Fuel pump to carburetor lines (6 cyl.) (stainless) | set |
| X628130 | 69 | Fuel pump to carburetor lines (350 2BBL) (3/8")(steel) | set |
| X628135 | 69 | Fuel pump to carburetor lines (350 2BBL) (3/8")(stainless) | set |
| X628140 | 69 | Fuel pump to carburetor lines (307 & 327 2BBL)(5/16")(steel) | set |
| X628145 | 69 | Fuel pump to carburetor lines (307 & 327 2BBL)(5/16")(stainless) | set |
| X628150 | 69 | Fuel pump to carburetor lines (396 Quad) (steel) | set |
| X628155 | 69 | Fuel pump to carburetor lines (396 Quad) (stainless) | set |
| X628160 | 69 | Fuel pump to carburetor lines (350 4BBL Quadrajete)(steel) | set |
| X628165 | 69 | Fuel pump to carburetor lines (350 4BBL Quadrajete)(stainless) | set |
| X628170 | 69 | Fuel pump to carburetor lines (396 - 375hp Holley)(with Y block)(steel) | set |
| X628175 | 69 | Fuel pump to carburetor lines (396 - 375hp Holley)(with Y block) (stainless) | set |
| X628180 | 70 | Fuel pump to carburetor lines (396 - 375hp)(steel) | set |
| X628185 | 70 | Fuel pump to carburetor lines (396 - 375hp)(stainless) | set |
| X628190 | 70-72 | Fuel pump to carburetor lines (350 - 300hp)(steel) | set |
| X628195 | 70-72 | Fuel pump to carburetor lines (350 - 300hp)(stainless) | set |
| X628200 | 71-72 | Fuel pump to carburetor lines (402 4BBL) (steel) | set |
| X628205 | 71-72 | Fuel pump to carburetor lines (402 4BBL) (stainless) | set |
| X628210 | 71-72 | Fuel pump to carburetor lines (350 - 270hp 4BBL)(steel) | set |
| X628215 | 71-72 | Fuel pump to carburetor lines (350 - 270hp 4BBL)(stainless) | set |
| X628230 | 72 | Fuel pump to carburetor lines (350 4BBL Quadrajete)(steel) | set |
| X628235 | 72 | Fuel pump to carburetor lines (350 4BBL Quadrajete)(stainless) | set |



1962 – 1979 Nova & Acadian Catalogue Volume 9

PHONE: (905)627-4527 ORDERS 1-866-767-2787 FAX (905)627-3210

Underhood & Drivetrain Parts

FRONT TO REAR FUEL LINES

In order to bring in the proper lines for your particular vehicle, please specify year and model, engine size, and size of line requested for either the main line, or return where applicable.

| | | | |
|---------|-------|--|------|
| X645500 | 62-78 | Front to rear fuel line (steel)(specify) | each |
| X645510 | 62-78 | Front to rear fuel line (stainless) (specify) | each |

VAPOUR RETURN LINES

| | | | |
|---------|-------|------------------------------------|-----|
| X627700 | 71-72 | Vapour return line set (steel) | set |
| X627710 | 71-72 | Vapour return line set (stainless) | set |

TRANSMISSION COOLER LINES

| | | | |
|---------|-------|---|------|
| X683000 | 62-67 | Transmission cooler lines (700R4 with large radiator)(steel) | pair |
| X683005 | 62-67 | Transmission cooler lines (700R4 with large radiator)(stainless) | pair |
| X683010 | 66-67 | Transmission cooler lines (powerglide without spacer at radiator)(steel) | pair |
| X683015 | 66-67 | Transmission cooler lines (powerglide without spacer at radiator)(stainless) | pair |
| X683020 | 66-67 | Transmission cooler lines (powerglide with 3" spacer at radiator)(steel) | pair |
| X683025 | 66-67 | Transmission cooler lines (powerglide with 3" spacer at radiator)(stainless) | pair |
| X683030 | 68-72 | Transmission cooler lines (powerglide 350, 400 with 12" span on rad)(steel) | pair |
| X683035 | 68-72 | Transmission cooler lines (powerglide 350, 400 with 12" span on rad)(stainless) | pair |
| X683040 | 68-72 | Transmission cooler lines (powerglide 350, 400 with 8" span on rad)(steel) | pair |
| X683045 | 68-72 | Transmission cooler lines (powerglide 350, 400 with 8" span on rad)(stainless) | pair |
| X683048 | 74-78 | Trans. cooler lines, V-8, T-350, (steel) | PAIR |
| X683049 | 74-78 | Trans. cooler lines, V-8, T-350 (stnlss) | PAIR |

TRANSMISSION VACUUM LINES

| | | | |
|---------|-------|---|------|
| X683050 | 67 | Transmission vacuum line (Turbo 400) (steel) | each |
| X683055 | 67 | Transmission vacuum line (Turbo 400) (stainless) | each |
| X683060 | 67-68 | Transmission vacuum line (Turbo 350 with left hand modulator)(steel) | each |
| X683065 | 67-68 | Transmission vacuum line (Turbo 350 with left hand modulator)(stainless) | each |
| X683070 | 67-69 | Transmission vacuum line (powerglide) (steel) | each |
| X683075 | 67-69 | Transmission vacuum line (powerglide) (stainless) | each |
| X683080 | 68-72 | Transmission vacuum line (Turbo 400) (steel) | each |
| X683085 | 68-72 | Transmission vacuum line (Turbo 400) (stainless) | each |
| X683090 | 69-70 | Transmission vacuum line (Turbo 350 with right hand modulator)(steel) | each |
| X683095 | 69-70 | Transmission vacuum line (Turbo 350 with right hand modulator)(stainless) | each |

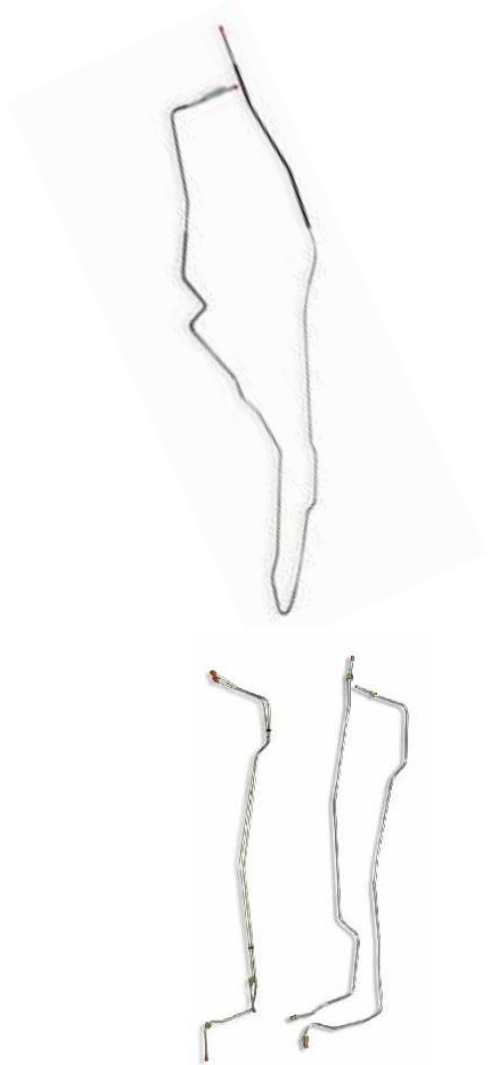

Underhood & Drivetrain Parts

PARK BRAKE CABLES

| | | | |
|---------|-------|--|------|
| X614550 | 68-74 | Park brake cable (front) | each |
| X614600 | 68-74 | Park brake cable (center) | each |
| X614650 | 68-74 | Park brake cable (rear) | each |
| X614680 | 64-67 | Park brake cable set, w/hardware, steel | SET |
| X614690 | 64-67 | Park brake cable set, w/hardware, stnlss | SET |
| X614700 | 68-74 | Park brake cable set, w/hardware, steel | SET |
| X614710 | 68-74 | Park brake cable set w/hardware, Stnless | SET |
| X614720 | 75-79 | Park brake cable set w/hardware, steel | SET |
| X614740 | 75-79 | Park brake cable set w/hardware, Stnless | SET |

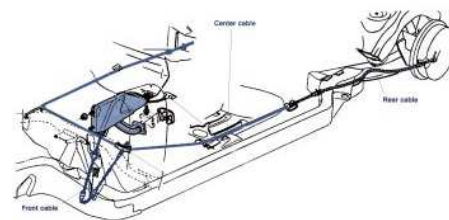

BRAKE HOSES

| | | | |
|---------|-------|---------------------------------------|------|
| X629000 | 62-66 | Front brake hose | each |
| X629010 | 67 | Front brake hose (with drum brakes) | each |
| X629015 | 67 | Front brake hose (with disc brakes) | each |
| X629020 | 68-72 | Front brake hose (with drum) | each |
| X629030 | 68-72 | Front brake hose (single piston disc) | each |
| X629100 | 62-65 | Rear brake hose | each |
| X629110 | 66-67 | Rear brake hose | each |
| X629120 | 68 | Rear brake hose | each |
| X629130 | 69-72 | Rear brake hose | each |



WHEEL CYLINDERS

| | | | |
|---------|-------|------------------------------|------|
| X629490 | 62-63 | Wheel cylinder (left front) | each |
| X629491 | 62-63 | Wheel cylinder (right front) | each |
| X629492 | 62-63 | Wheel cylinder (left rear) | each |
| X629493 | 62-63 | Wheel cylinder (right rear) | each |
| X629500 | 65-67 | Wheel cylinder (left front) | each |
| X629502 | 65-67 | Wheel cylinder (right front) | each |
| X629505 | 68-69 | Wheel cylinder (left front) | each |
| X629507 | 68-69 | Wheel cylinder (right front) | each |
| X629510 | 65-75 | Wheel cylinder (rear) | each |



DISC BRAKE PARTS

| | | | |
|---------|-------|---|------|
| X650000 | 62-74 | Single piston caliper brackets | pair |
| X650010 | 62-74 | Power brake booster & master cylinder (7" booster) | kit |
| X650020 | 62-74 | Power brake booster (7") | each |
| X650030 | 62-74 | Power booster adaptor brackets (for mounting the booster to firewall) | pair |
| X650040 | 62-74 | Proportioning valve, bracket & lines to master cylinder | kit |
| X650050 | 62-74 | Spindles (for disc brakes) | pair |
| X650060 | 62-74 | Disc brake backing plates (front only) | pair |
| X650070 | 62-74 | Disc brake spindles, caliper brackets and dust shields (two front wheels) | set |



NO BRAINER BRAKE LINE KITS

Now all brake lines that need to be changed when converting from original drum brake to disc are now available in one handy kit. They include all the front, front to rear and rear axle lines as well as mounting clips. **Note:** specify year.

| | | | |
|---------|-------|---|-----|
| X650092 | 62-72 | "No Brainer" brake line kit | SET |
| X650097 | 62-72 | "No Brainer" brake line kit (stainless) | SET |



X650000



X650050

1962 – 1979 Nova & Acadian Catalogue Volume 9

PHONE: (905)627-4527 ORDERS 1-866-767-2787 FAX (905)627-3210



Underhood & Drivetrain Parts

FRONT DISC BRAKE CONVERSION KITS

We have tried a few different suppliers and we have found that the **Right Stuff Detailing** has the best kit available for your 15" wheels at the right price. A complete disc brake conversion kit is available and includes the following:

- Booster with dual master cylinder, bracket & rod with clevis to mount to the firewall (see side bar for optional sizes available for extra cost)
- 2 rotors
- 2 hoses
- Dust caps
- roller bearings
- disc brake spindles
- Proportioning valve & hardware
- 2" drop spindles (where applicable)
- Detailed instructions
- 2 calipers & pads
- 2 seals
- set of caliper brackets with hardware
- Mounting bolts
- Backing plates (dust shields)(Note! does not work with 2" drop spindles)
- Bleeder kit
- Optional upgrades available

The complete disc brake kit does not include the hard lines from the proportioning valve to the brakes. It is so much easier if you buy them, however. Makes the whole job much easier, and will save you money in the long run.

| | | | |
|----------|-------|--|-----|
| X650075 | 62-67 | Front power disc brake changeover kit | kit |
| X650075A | 62-67 | Front manual disc brake changeover kit | kit |
| X650075B | 62-67 | Front power disc brake & drop spindle changeover kit | kit |
| X650080 | 68-72 | Front power disc brake changeover kit | kit |
| X650080A | 68-72 | Front manual disc brake changeover kit | kit |
| X650080B | 68-72 | Front power disc brake & drop spindle changeover kit | kit |



TAKE YOUR CHOICE!

- 7" dual diaphragm booster. Use if vacuum is low
- 8" dual diaphragm booster. Use if vacuum is very low
- 9" single slimline booster. Good for most conversions
- 9" Delco style booster. Use for 64-66 authentic appearance & for 67-72 if clearance of 11" is a problem
- 11" Delco style booster. Looks authentic for 67-72. Lots of vacuum

OTHER ALTERNATIVES

(add \$50.00 to the changeover kit)

- 9" Delco style booster. Stamped "Delco Moraine" for authenticity
- 11" Delco style booster. Stamped "Delco Moraine" for authenticity

14" FRONT DISC BRAKE CONVERSION

Now you can keep your original 14", 5 bolt drum brake wheels! The special caliper brackets plus a different set of rotors, calipers, hoses & bearings are included to be used with your original spindles. **Note:** this kit has the same booster options found on the previous page!

X650085 62-74 Power front disc brakes for 14" wheels KIT

1962 – 1979 Nova & Acadian Catalogue Volume 9

PHONE: (905)627-4527 ORDERS 1-866-767-2787 FAX (905)627-3210

Underhood & Drivetrain Parts

REAR DISC CONVERSION KIT

We can now offer rear disc conversion kits available from Right Stuff Detailing. Please measure you're the width of your rear axle flanges (should be 3.125") to ensure you get the appropriate kit. The complete kit includes the following;

- GM rotors
- New loaded calipers
- Caliper brackets & spacers
- Bracket hardware
- Flex hoses & brackets
- Emergency brake cables

X650087 62-74 Rear disc brake conversion kit KIT



**SAVE \$\$\$!!!
BUY BOTH THE FRONT &
REAR DISC BRAKE
CONVERSIONS AND SAVE!**

SUSPENSION

| | | | |
|-----------------------|-------|---|------|
| X694900 | 62-67 | Spring perch (front upper) | each |
| X695000 | 63-67 | Basic front suspension kit | kit |
| X695010 | 63-67 | Major front suspension kit | kit |
| X695020 | 68-72 | Basic front suspension kit | kit |
| X695030 | 68-72 | Major front suspension kit | kit |
| X695040 | 73-74 | Basic front suspension kit | kit |
| X695050 | 73-74 | Major front suspension kit | kit |
| X695100 | 63-67 | Tie rod sleeve | each |
| X695110 | 68-74 | Tie rod sleeve | each |
| X695150 | 63-67 | Tie rod end (inner) | each |
| X695155 | 63-67 | Tie rod end (outer) | each |
| X695160 | 68-74 | Tie rod end (inner) | each |
| X695165 | 63-74 | Tie rod end (outer) | each |
| X695200 | 63-67 | Idler arm bushings | set |
| X695205 | 68-74 | Idler arm | each |
| X695250 | 63-67 | Ball joint (upper) | each |
| X695255 | 63-67 | Ball joint (lower) | each |
| X695260 | 68-74 | Ball joint (upper) | each |
| X695265 | 68-74 | Ball joint (lower) | each |
| X306250 | 68-74 | A-arm bumper (upper) | each |
| X306500 | 68-72 | A-arm bumper (lower) | each |
| X695300 | 63-67 | Control arm bushing (upper) | each |
| X695305 | 63-67 | Control arm bushing (lower) | each |
| X695310 | 68-74 | Control arm bushing (upper) | each |
| X695315 | 68-74 | Control arm bushing (68-74 front lower, 73-74 rear lower) | each |
| X695320 | 68-72 | Control arm bushing (rear lower) | each |
| X695400 | 63-74 | Stabilizer links | pair |
| X695410 | 62-67 | Sway bar (front) and mounting kit | KIT |
| <u>POWER STEERING</u> | | | |
| X696000 | 62-67 | Power steering cylinder | each |
| X696010 | 62-67 | Power steering control valve | each |



WINDSHIELD WASHERS

1962 – 1979 Nova & Acadian Catalogue Volume 9
PHONE: (905)627-4527 ORDERS 1-866-767-2787 FAX (905)627-3210



Underhood & Drivetrain Parts

| | | | |
|---------|-------|--|------|
| X606590 | 62-67 | Windshield washer spray nozzles | pair |
| X606600 | 68-72 | Windshield washer spray nozzles | pair |
| X607000 | 62-70 | Windshield washer jar bracket (62-67 requires a bracket to be transfer from the old one) | each |
| X405750 | 62-70 | Windshield washer jar, cap, hose, filter | set |
| X406000 | 71-74 | Windshield washer jar and cap | set |
| X513160 | 62-64 | Wiper switch (single speed) | each |
| X513170 | 63-64 | Wiper switch (2 speed) | each |
| X513180 | 65-66 | Wiper switch (single speed) | each |
| X513200 | 67-68 | Wiper switch (2 speed) | each |
| X513300 | 69-71 | Wiper switch (2 speed) | each |
| X513310 | 72-74 | Wiper switch (2 speed) | each |
| X513400 | 63-74 | Windshield washer pump | each |



X513160



X513300

FAN SHROUDS

| | | | |
|---------|-------|-------------------------------------|------|
| X407350 | 65-67 | Fan shroud (V-8, 65 with air cond.) | each |
| X407500 | 69-72 | Fan shroud (small block, V-8) | each |
| X407750 | 69-70 | Fan shroud (big block) | each |



X407500



X407750

UNDERHOOD HOSES & RELATED

| | | | |
|---------|-------|--------------------------------------|-----|
| X604500 | 62-68 | Radiator and heater hose clamps (SB) | set |
|---------|-------|--------------------------------------|-----|



| | | | |
|---------|-------|--|------|
| X604750 | 69-79 | Radiator and heater hose clamps (SB) | set |
| X605000 | 69-79 | Radiator and heater hose clamps (BB) | set |
| X605250 | 68-72 | Heater hose clamp (on inner fender) | each |
| X306600 | 66-67 | Radiator hose (specify year, engine, A/C | each |
| X307000 | 62-72 | Heater hoses (with GM markings, 55" long, 5/8" and 3/4" diameters) | pair |
| X307250 | 69-72 | Water pump bypass hose (straight) | each |
| X307360 | | Water pump bypass hose (with elbow) | each |
| X307500 | 67-72 | PCV hose (with molded 90 degree end, 35" long) | each |
| X307750 | 64-72 | Gas line to fuel pump hose (with clips) | each |



X605250



HEATER BOX & RELATED

| | | | |
|----------|-------|----------------------------------|------|
| *X697000 | 67-75 | Heater box (small block, no air) | each |
| *X697010 | 68-70 | Heater box (big block) | each |
| *X697020 | 69-72 | Heater case (core section) | each |
| *X697040 | 68-74 | Heater blower motor (no air) | each |



UNDERHOOD WIRE RETAINING



X408250



X408500

| | | | |
|---------|-------|------------------------------------|------|
| X408250 | 62-72 | Inner fender wire retainer (black) | each |
| X408500 | 66-72 | Firewall wiring gutter | each |

OTHER UNDERHOOD PARTS

| | | | |
|---------|-------|---|------|
| X655500 | 64-67 | Oil filler cap (283,327) | each |
| X662080 | 68-72 | Transmission cross member (turbo 400) | each |
| X605750 | 64-66 | Exhaust manifold bolt set, exact orig., | set |
| X605760 | 64-79 | Exhaust manifold bolt set, replacement, | SET |
| X606000 | 66-67 | Spark plug heat shields (V-8 small block) | set |
| X606100 | 68-71 | Spark plug heat shields (big block) | set |
| X639740 | ALL | Steering shaft rag joint repair kit | kit |



X655500



MOTOR MOUNTS

1962 - 1979 Nova & Acadian Catalogue Volume 9
 PHONE: (905)627-4527 ORDERS 1-866-767-2787 FAX (905)627-3210



X662000



Underhood & Drivetrain Parts

| | | | |
|---------|-------|-------------------------------------|-------------|
| X662000 | 62-67 | Motor mount brackets (V-8) | pair |
| X662010 | 66-67 | Motor mount brackets (6 cyl) | pair |
| X662050 | 68-72 | Motor mount brackets (small block) | pair |
| X662060 | 62-67 | Transmission mount support (left) | each |
| X662065 | 62-67 | Transmission mount support (right) | each |



CHEVY II NOVA 400 SPORT COUPE in Autumn Gold. Like all Chevy II models, this Sport Coupe glows with Magic-Mirror acrylic lacquer finish.

1962 – 1979 Nova & Acadian Catalogue Volume 9

PHONE: (905)627-4527 ORDERS 1-866-767-2787 FAX (905)627-3210

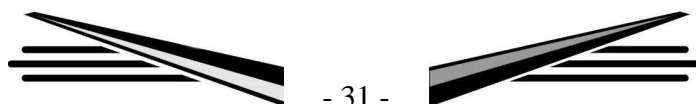

Door Related & Locks

VENT WINDOW FRAMES

| | | | |
|---------|-------|---------------------------|------|
| X244010 | 62-67 | Vent window frame (left) | each |
| X244020 | 62-67 | Vent window frame (right) | each |
| X244030 | 68-72 | Vent window frame (left) | each |
| X244040 | 68-72 | Vent window frame (right) | each |



2 DOOR DOOR GLASS FRAMES

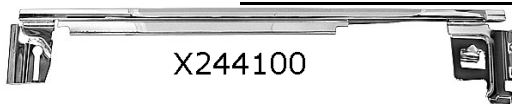

| | | | |
|---------|-------|--|------|
| X244100 | 62-65 | Door glass channel(left lower) | each |
| X244110 | 62-65 | Door glass channel(right lower) | each |
| X244120 | 62-65 | Door glass upper frames (HT/conv) | pair |
| X244125 | 62-65 | Upper quarter glass frames (HT only) | pair |
| X244130 | 62-63 | Upper quarter glass frames (conv only) | pair |

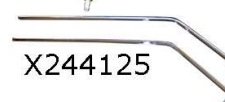

DOOR LOCK STRIKERS

| | | | |
|----------|-------|----------------------------------|------|
| X612020 | 68-72 | Door lock striker (replacement) | each |
| X612020A | 68-72 | Door lock striker (reproduction) | each |



DOOR HINGES & RELATED

| | | | |
|---------|-------|--|------|
| X612500 | 62-66 | Door hinge (upper, left or right)(can be modified and used on 67 models) | each |
| X612550 | 62-67 | Door hinge (lower, left) | each |
| X612550 | 62-67 | Door hinge (lower, right) | each |
| X612600 | 68-72 | Door hinge (left upper) | each |
| X612610 | 68-72 | Door hinge (right upper) | each |
| X612620 | 68-72 | Door hinge (left lower) | each |
| X612630 | 68-72 | Door hinge (right lower) | each |



| | | | |
|---------|-------|---|------|
| X612700 | 62-67 | Door hinge screws (12 pc)(2 hinges) | set |
| X612705 | 68-72 | Door hinge screws (upper)(14 pc) (does both hinges) | set |
| X612710 | 68-72 | Door hinge screws (lower)(16 pc) (does both hinges) | set |
| X612750 | 62-79 | Door hinge pin | each |
| X613000 | 62-74 | Door hinge bushing (small) | each |
| X613250 | 68-79 | Door hinge bushing (large) | each |



DOOR ALIGNMENT WEDGES

| | | | |
|---------|-------|---------------------------------|-----|
| X613300 | 63 | Door alignment wedges (conv.) | set |
| X613320 | 66-67 | Door alignment wedges (hardtop) | set |

DOOR LATCHES & CONTROLS

| | | | |
|---------|-------|-------------------------------|------|
| X617350 | 66-67 | Door latch (2Dr HT)(left) | each |
| X617355 | 66-67 | Door latch (2Dr HT)(right) | each |
| X617360 | 66-67 | Door latch controller (left) | each |
| X617362 | 66-67 | Door latch controller (right) | each |
| X617370 | 69-70 | Door latch (2Dr)(left) | each |
| X617375 | 69-70 | Door latch (2Dr)(right) | each |

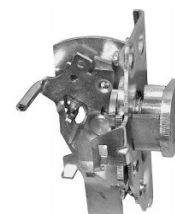

X617355

X617360

1962 – 1979 Nova & Acadian Catalogue Volume 9

PHONE: (905)627-4527 ORDERS 1-866-767-2787 FAX (905)627-3210

Door Related & Locks

LOCKS

| | | | |
|---------|-------|---|------|
| X614760 | 62-66 | Door lock cylinders (with original keys) | pair |
| X614765 | 67-68 | Door lock cylinders (with original keys) | pair |
| X614770 | 62-78 | Door lock cylinders (with keys) | pair |
| X614800 | 62-65 | Glove box cylinder (with keys) | each |
| X614805 | 62-65 | Glove box cylinder (with original keys) | each |
| X614810 | 66-67 | Glove box cylinder (with keys) | each |
| X614815 | 66-67 | Glove box cylinder (with original keys) | each |
| X614817 | 68 | Glove box cylinder (with original keys) | each |
| X614820 | 68-72 | Glove box cylinder (with keys) | each |
| X614900 | 62-64 | Ignition cylinder (with original keys) | each |
| X614910 | 65 | Ignition cylinder (with original keys) | each |
| X614915 | 66-67 | Ignition cylinder (with original keys) | each |
| X615060 | 68 | Ignition cylinder (with keys) | each |
| X615070 | 68 | Ignition cylinder (with original keys) | each |
| X615090 | 69-78 | Ignition cylinder (with keys) | each |
| X615100 | 62-79 | Trunk lock cylinder (with keys) | each |
| X615102 | 62-79 | Trunk lock w/GM oval keys, orig. 69-79 | EACH |
| X615104 | 62-67 | Trunk lock cylinder (with original keys) | each |
| X615106 | 68 | Trunk lock cylinder (with original keys) | each |
| X615107 | 68-72 | Trunk lock retainer | each |
| X615110 | 62-64 | Ignition and door lock cylinders (with keys) | set |
| X615115 | 62-64 | Ignition and door lock cylinders (with original keys) | set |
| X615120 | 65 | Ignition and door lock cylinders (with original keys) | set |
| X615125 | 62-64 | Ignition and door lock cylinders (with original keys) | set |
| X615130 | 66-67 | Ignition and door lock cylinders (with keys) | set |
| X615145 | 66-67 | Ignition and door lock cylinders (with original keys) | set |
| X615150 | 68 | Ignition and door lock cylinders (with keys) | set |
| X615155 | 68 | Ignition and door lock cylinders (with original keys) | set |
| X615160 | 69-78 | Ignition and door lock cylinders (with GM square keys) | set |
| X615170 | 62-65 | Glove box and trunk lock cylinders (with keys) | set |
| X615175 | 62-65 | Glove box and trunk lock cylinders (with original keys) | set |
| X615180 | 66-67 | Glove box and trunk lock cylinders (with keys) | set |
| X615185 | 66-67 | Glove box and trunk lock cylinders (with original keys) | set |
| X615190 | 68-79 | Glove box and trunk lock cylinders (with keys) | set |
| X615200 | 68 | Glove box and trunk lock cylinders (with original keys) | set |
| X615210 | 62-78 | Door and trunk lock retainer (universal) | each |
| X615109 | 62-79 | Trunk lock shaft | EACH |
| A661220 | 62-66 | Key blank (pear shaped) | each |
| A661225 | 62-66 | Key blank (octagon shaped) | each |
| A661230 | 67 | Key blank (pear shaped) | each |
| A661235 | 67 | Key blank (octagon shaped) | each |
| A661240 | 68 | Key blank (pear shaped) | each |
| A661245 | 68 | Key blank (octagon shaped) | each |
| A661250 | 69-78 | Key blank (round head)(specify year) | each |
| A661255 | 69-78 | Key blank (square head)(specify year) | each |



X615107



1962 – 1979 Nova & Acadian Catalogue Volume 9

PHONE: (905)627-4527 ORDERS 1-866-767-2787 FAX (905)627-3210



Decals

Air Cleaner

"Small Block" Decals

DC101 194 HI-THRIFT
 DC102 194 HI-THRIFT 120 HP
 DC103 230 TURBO-THRIFT
 DC104 230 TURBO-THRIFT 140 HP



DC105 250 TURBO-THRIFT
 DC105B 250 TURBO-THRIFT (RECT.)
 DC105C 250 TURBO-THRIFT 145 HP
 DC106 250 TURBO-THRIFT 155 HP
 DC106B 283 TURBO-FIRE
 DC107 283 TURBO-FIRE 170 HP
 DC108 283 TURBO-FIRE 195 HP
 DC108B 283 TURBO-FIRE 220 HP
 DC109 302 TURBO-FIRE 290 HP
 DC109B 305 TURBO-FIRE
 DC109C 305 TURBO-FIRE 175 HP
 DC110 307 TURBO-FIRE 175 HP



DC110B 307 TURBO-FIRE
 DC111 307 TURBO-FIRE 200 HP
 DC111B 327 TURBO-FIRE
 DC112 327 TURBO-FIRE 185 HP
 DC113 327 TURBO-FIRE 200 HP
 DC114 327 TURBO-FIRE 210 HP



DC114B 327 TURBO-FIRE 230 HP
 DC115A 327 TURBO-FIRE 235 HP
 DC115B 327 TURBO-FIRE 250 HP
 DC116 327 TURBO-FIRE 275 HP
 DC117 327 TURBO-FIRE 300 HP
 DC118 327 TURBO-FIRE 325 HP
 DC119 327 TURBO-FIRE 350 HP
 DC119B 327 TURBO-FIRE 365 HP
 DC119C 350 TURBO-FIRE
 DC120A 350 TURBO-FIRE 225 HP
 DC120B 350 TURBO-FIRE 240 HP
 DC121 350 TURBO-FIRE 245 HP
 DC122 350 TURBO-FIRE 250 HP
 DC123 350 TURBO-FIRE 255 HP
 DC124 350 TURBO-FIRE 270 HP
 DC125 350 TURBO-FIRE 285 HP
 DC126 350 TURBO-FIRE 295 HP
 DC127 350 TURBO-FIRE 300 HP
 DC128 350 TURBO-FIRE 325 HP
 DC129 350 TURBO-FIRE 330 HP
 DC130 350 TURBO-FIRE 350 HP
 DC131 350 TURBO-FIRE 360 HP
 DC132 350 TURBO-FIRE 370 HP
 DC132B 400 TURBO-FIRE
 DC133 400 TURBO-FIRE 255 HP
 DC134 400 TURBO-FIRE 265 HP



DC135 400 TURBO-FIRE 300 HP

Crankcase Breather

Decals

DC268 RED, WHITE, BLUE (64-67)
 DC269 BLACK & GOLD (59-63)

**WARNING... ALWAYS CONNECT
 POSITIVE TO POSITIVE**

NEGATIVE TO NEGATIVE

When Using Battery Charger or Booster
 To Prevent Damage to Electrical System.

Warning Decals

DC289 WARNING CONNECT POSITIVE
 TO POSITIVE
 DC290 GENERATOR TERMINAL TAG

Air Cleaner

"Big Block" Decals



DC136 396 CROSS FLAGS
 DC137 427 CROSS FLAGS
 DC138 454 CROSS FLAGS
 DC139A 400 CROSS FLAGS
 DC139B 402 CROSS FLAGS
 DC139C 502 CROSS FLAGS



Tri-Power Air Cleaner Decals

DC140 TRI-POWER 400 HP
 DC141 TRI-POWER 435 HP

Big Block

Turbo-Jet Decals

DC900 TURBO JET 330 HP
 DC901 TURBO-JET 265 HP
 DC901B TURBO-JET 300 HP
 DC902 TURBO-JET 325 HP
 DC903 TURBO-JET 335 HP
 DC904 TURBO-JET 345 HP
 DC905 TURBO-JET 350 HP
 DC905B TURBO-JET 355 HP
 DC906 TURBO-JET 360 HP
 DC906B TURBO-JET 365 HP
 DC907 TURBO-JET 375 HP
 DC908 TURBO-JET 385 HP
 DC909 TURBO-JET 390 HP
 DC910 TURBO-JET 400 HP
 DC911 TURBO-JET 425 HP
 DC912 TURBO-JET 450 HP
 DC913 TURBO-JET 460 HP
 DC914 TURBO-JET 396/300 HP
 DC915 TURBO-JET 400/300 HP
 DC916 TURBO-JET 454/365 HP
 DC917 TURBO-JET 454/425 HP

Horsepower Decals

DC242 396/375 HP
 DC243 396/450 HP

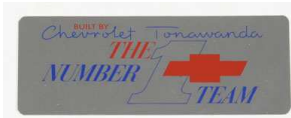

Valve Cover Decals

DC241 TONAWANDA NUMBER 1 TEAM
 DC241B FLINT #1 TEAM (SMALL
 BLOCK)



Valve Cover Decals

DC420 153 SUPER-THRIFT
 DC220B 194 HI-THRIFT
 DC220 194 HI-THRIFT 120 HP
 DC221 230 TURBO-THRIFT 125 HP
 DC223 230 TURBO-THRIFT 150 HP
 DC224 230 TURBO-THRIFT 155 HP
 DC225 235 HIGH-THRIFT
 DC226 250 TURBO-THRIFT
 DC227 250 TURBO-THRIFT
 DC228 250 TURBO-THRIFT 135 HP

DECALS

Valve Cover Decals

DC229 250 TURBO-THRIFT 150 HP
 DC230 250 TURBO-THRIFT 155 HP
 DC231 283 TURBO-FIRE
 DC232 283 TURBO-FIRE 195 HP
 DC233 283 TURBO-FIRE 220 HP
 DC234 327 TURBO-FIRE
 DC235 327 TURBO-FIRE 275 HP
 DC236 327 TURBO-FIRE 300 HP
 DC237 327 TURBO-FIRE 350 HP
 DC238 409 TURBO-FIRE
 DC244 396 TURBO-FIRE 325 HP
 DC212A 220 HP (GOLD)
 DC212B 230 HP (GOLD)
 DC213 245 HP (ORANGE)
 DC214 250 HP (ORANGE)
 DC215 270HP (ORANGE)
 DC218 275 HP (ORANGE)
 DC219 283 HP (ORANGE)
 DC216 290 HP (ORANGE)
 DC217 315 HP (ORANGE)
 DC400 170 HORSEPOWER
 DC401 185 HORSEPOWER
 DC402 195 HORSEPOWER

Valve Cover Decals

DC200 210 HORSEPOWER
 DC403 220 HORSEPOWER
 DC404 230 HORSEPOWER
 DC405 245 HORSEPOWER
 DC201 250 HORSEPOWER
 DC406 260 HORSEPOWER
 DC407 270 HORSEPOWER



DC202 275 HORSEPOWER
 DC408 280 HORSEPOWER
 DC409 290 HORSEPOWER
 DC203 300 HORSEPOWER
 DC410 305 HORSEPOWER
 DC411 315 HORSEPOWER

1962 - 1979 Nova & Acadian Catalogue Volume 9

PHONE: (905)627-4527 ORDERS 1-866-767-2787 FAX (905)627-3210

Decals

1973

- DC980B 307-2 AT/MT US & CA (WC)
- DC981B 350-2 AT/MT US & CA (WF)
- DC981 L-48 350 AT/MT (WI)
- DC982 L-82 & Z/28 AT/MT US & CA (WK)
- DC982B 400-2 AT US & CA (WM)
- DC983 454-4 AT/MT US & CA (WN)

Air Conditioning

Compressor Labels

- DC520 63-65 CHEVROLET
- DC521 66 CHEVROLET
- DC522 66 CHEVROLET (GREEN)
- DC525 67 CHEVROLET
- DC526 67 CHEVROLET & VETTE



- DC527 67-68 CHEVROLET (GREEN)
- DC530 68 CHEVROLET
- DC535 69 CHEVROLET (RED)
- DC536 69-71 CHEVROLET (GREEN)
- DC540 70 CHEVROLET (RED)
- DC545 71 CHEVROLET (RED)
- DC550 72 CHEVROLET (RED)
- DC551 72-73 CHEVROLET (GREEN)
- DC560 74-76 CHEVROLET (GREEN)



Air Conditioning

Firewall Box Labels

- DCN400 65 ALL W/A.C. EBA-70-65B
- DCN401 66 ALL W/A.C. EBA-70-66B
- DCN402 67 ALL W/A.C. EBA-70-67B
- DCN403 68 ALL W/A.C. EBA-70-68B
- DCN404 69 ALL W/A.C. EBA-70-69B
- DCN405 70 ALL W/A.C. EBA-70-70B
- DCN406 71 ALL W/A.C. EBA-70-81B
- DCN407 72 ALL W/A.C. EBA-70-72B
- DCN408 73 ALL W/A.C. EBA-70-73B
- DCN409 74 ALL W/A.C. EBA-70-74B
- DCN410 75 ALL W/A.C. EBA-70-75B
- DCN411 76 ALL W/A.C. EBA-70-76B

Cooling System

Decals

- DC281A 61-64 CAUTION (BOXED)
- DC275 CAUTION (AFT. 12/62 TILL 4/64)
- DC281 64-65 ALL CAUTION
- DC263 70-72 ALL FACTORY COOLANT
- DC271 73-74 ALL FACTORY COOLANT
- DC262 74-77 "WARNING ENGINE COOLANT ONLY"



Caution Decals

- DC930 "KEEP FINGERS CLEAR" BRIGHT ORANGE & BLACK

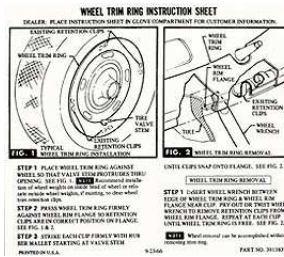

Glove Box Misc.

- DC806 TRIM RING CARD
- DC826 SPARE WHEEL CARRIER LOCK INSTRUCTION SHEET
- DC820 66-67 AM-FM INSTRUCT.
- DC822 ACRYLIC LACQUER PAINT NOTICE CARD
- DC823 CARE & USE OF SEAT BELTS



Air Cleaner Service

Instructions

- DC153 64-65 CHEVELLE & CHEVY II 283 & 327 W/4BL
- DC145 62-66 W/A86CW ELEMENT
- DC154 64-66 CHEVY II 6 CYL. (64187350)
- DC147 65-67 W/A212CW (6421746)
- DC151 65-66 CHEVELLE (EX. SS) V8-2 (6420901)
- DC144 65-66 CHEVY II W/A86CW 67 CHEVY II 283 W/A.C. (1ST DESIGN, 2 TUBES) (6424492)
- DC143 (6424826 PP) 68-72 ALL
- DC307 (6485257 CD) 70 NOVA & CHEVELLE 396 S/H/P 71 CHEVELLE 454 S/H/P



Door Stickers

- DC297 67 Mark of Excellence (turquoise)
- DC298 68-75 Mark of Excellence (blue)



Misc. Engine

Compartment Decals

- DC299 OPTIKLEEN LABEL
- DCN289 KLEERVIEW LABEL
- DCN299 WINDSHIELD WASHER LABEL

(ALL OF THE ABOVE FOR THE TRIANGULAR BOTTLE)
DC276 "WINTERIZED"



1962 - 1979 Nova & Acadian Catalogue Volume 9

PHONE: (905)627-4527 ORDERS 1-866-767-2787 FAX (905)627-3210

Clips & Fasteners

INTERIOR TRIM SCREW KITS

| | | | |
|---------|-------|----------------------------------|-----|
| X660000 | 62 | Interior trim screw kit (2Dr Ht) | kit |
| X660010 | 62 | Interior trim screw kit (Conv) | kit |
| X660015 | 63 | Interior trim screw kit (Conv) | kit |
| X660020 | 63-65 | Interior trim screw kit (2Dr Ht) | kit |
| X660025 | 66 | Interior trim screw kit (2Dr Ht) | kit |
| X660045 | 70 | Interior trim screw kit (2Dr) | kit |
| X660050 | 71 | Interior trim screw kit (2Dr) | kit |
| X660060 | 73 | Interior trim screw kit (2Dr) | kit |



EXTERIOR TRIM SCREW KITS

| | | | |
|---------|----|-------------------------|-----|
| X660500 | 62 | Exterior trim screw kit | kit |
| X660530 | 65 | Exterior trim screw kit | kit |
| X660540 | 66 | Exterior trim screw kit | kit |
| X660550 | 67 | Exterior trim screw kit | kit |
| X660580 | 70 | Exterior trim screw kit | kit |
| X660590 | 71 | Exterior trim screw kit | kit |
| X660610 | 73 | Exterior trim screw kit | kit |
| X660620 | 74 | Exterior trim screw kit | kit |



FRONT END SHEET METAL FASTENER KITS

| | | | |
|---------|-------|------------------------------------|------|
| X621000 | 62-67 | Front-end sheet metal fastener kit | each |
| X621100 | 68-72 | Front-end sheet metal fastener kit | each |

BODY ASSEMBLY FASTENER KITS

Typical kit includes fasteners to attach: back-up lamps, battery tray, bumpers & brackets & guards, bumper filler panel, cowl panel, door latches, fender & braces & extensions & splash shields, grille & brackets & mouldings, headlamp bezels, housings & adjusters, header panel, hood & hinges, hood levelers, hood catch & lock plate, hood catch support, hood mouldings, license plate brackets, market lamps, name plates, park lamps, tail lamps, trunk latch & striker, trunk lid, valance, wheel houses & brackets.

| | | | |
|---------|-------|---|-----|
| X623050 | 64 | Body assembly fastener kit (373 pieces) | kit |
| X623055 | 65 | Body assembly fastener kit (380 pieces) | kit |
| X623060 | 66 | Body assembly fastener kit (380 pieces) | kit |
| X623065 | 67 | Body assembly fastener kit (381 pieces) | kit |
| X623070 | 68 | Body assembly fastener kit (317 pieces) | kit |
| X623075 | 69 | Body assembly fastener kit (321 pieces) | kit |
| X623080 | 70 | Body assembly fastener kit (312 pieces) | kit |
| X623085 | 71-72 | Body assembly fastener kit (312 pieces) | kit |



MASTER CHASSIS ASSEMBLY KIT

Typical kit includes fasteners to attach: accelerator lever & support, axle housing, springs, axle retainer plates, brake booster & hose, brake cables, brake plates, brake hose retainers & brackets, brake valve & pressure switch, calipers & brackets & shields, upper & lower control arms, control arm bushings, differential cover, driveshaft, engine mounts, fuel filler neck cover, fuel hoses, gas tank, grease fittings, idler arm, leaf spring hangers & front eye, master cylinder & push rod, park brake control, pitman arm, radius rod & bracket & bumper, shackles (nuts), shocks & brackets, stabilizer bar brackets & end links (includes rubber), steering gear & rag joint, steering linkage & ball joints, speedo cable, transmission, suspension bumpers, transmission cross member & insulator and wheel cylinders.

| | | | |
|---------|-------|---|-----|
| X632100 | 64-65 | Master chassis assembly kit (small block, drum brakes)(448 pcs) | kit |
| X632100 | 66 | Master chassis assembly kit (small block, drum brakes)(443 pcs) | kit |
| X632100 | 67 | Master chassis assembly kit (small block, drum brakes)(449 pcs) | kit |
| X632100 | 67 | Master chassis assembly kit (small block, disc brakes)(454 pcs) | kit |
| X632100 | 68 | Master chassis assembly kit (small block, drum brakes, mono leaf)(338 pcs) | kit |
| X632100 | 68 | Master chassis assembly kit (small block, drum brakes, multi leaf)(336 pcs) | kit |
| X632100 | 68 | Master chassis assembly kit (small block, disc brakes, mono leaf)(345 pcs) | kit |
| X632100 | 68 | Master chassis assembly kit (small block, disc brakes, mono leaf)(345 pcs) | kit |



1962 – 1979 Nova & Acadian Catalogue Volume 9

PHONE: (905)627-4527 ORDERS 1-866-767-2787 FAX (905)627-3210



Clips & Fasteners

| | | | |
|---------|-------|---|-----|
| | | block, disc brakes, multi leaf)(343 pcs) | |
| X632100 | 68 | Master chassis assembly kit (big block, disc brakes, multi leaf)(344 pcs) | kit |
| X632100 | 69 | Master chassis assembly kit (small block, drum brakes, mono leaf)(348 pcs) | kit |
| X632100 | 69 | Master chassis assembly kit (small block, drum brakes, multi leaf)(352 pcs) | kit |
| X632100 | 69 | Master chassis assembly kit (small block, disc brakes, mono leaf)(345 pcs) | kit |
| X632100 | 69 | Master chassis assembly kit (small block, disc brakes, multi leaf)(351 pcs) | kit |
| X632100 | 69 | Master chassis assembly kit (big block, disc brakes, multi leaf)(352 pcs) | kit |
| X632100 | 70 | Master chassis assembly kit (small block, drum brakes, mono leaf)(346 pcs) | kit |
| X632100 | 70 | Master chassis assembly kit (small block, drum brakes, multi leaf)(350 pcs) | kit |
| X632100 | 70 | Master chassis assembly kit (small block, disc brakes, mono leaf)(344 pcs) | kit |
| X632100 | 70 | Master chassis assembly kit (small block, disc brakes, multi leaf)(374 pcs) | kit |
| X632100 | 70 | Master chassis assembly kit (big block, disc brakes, multi leaf)(375 pcs) | kit |
| X632100 | 71-72 | Master chassis assembly kit (small block, drum brakes, mono leaf)(353 pcs) | kit |
| X632100 | 71-72 | Master chassis assembly kit (small block, drum brakes, multi leaf)(349 pcs) | kit |
| X632100 | 71-72 | Master chassis assembly kit (small block, disc brakes, mono leaf)(356 pcs) | kit |
| X632100 | 71-72 | Master chassis assembly kit (small block, disc brakes, multi leaf)(378 pcs) | kit |



Sheet Metal Parts

HEADLAMP BUCKET MUD CAPS

| | | | |
|---------|-------|--------------------------------------|------|
| X700000 | 62-65 | Headlamp bucket mud cap (fiberglass) | pair |
| X700020 | 66-67 | Headlamp bucket mud cap (fiberglass) | pair |
| X700070 | 66 | Headlamp bucket (left) | each |
| X700075 | 66 | Headlamp bucket (right) | each |



X700070



X700080



X700000



X700020

| | | | |
|---------|----|-------------------------|------|
| X700080 | 67 | Headlamp bucket (left) | each |
| X700085 | 67 | Headlamp bucket (right) | each |

GRILLE TO BUMPER FILLER PANELS

| | | | |
|---------|-------|-------------------------------|------|
| X700100 | 63-65 | Grille to bumper filler panel | each |
|---------|-------|-------------------------------|------|



X700110



X405500

| | | | |
|---------|-------|--|------|
| X700110 | 66-67 | Grille to bumper filler panel | each |
| X405500 | 68-72 | Grille to bumper filler panel (plastic) | each |
| X405510 | 68-72 | Grille to bumper filler panel (N.O.S.) (while quantities last) | each |
| X700150 | 68-74 | Grille to bumper filler panel steel reinforcement | each |



X700150

HOODS

| | | | |
|---------|-------|------------------------------|------|
| X716750 | 62-65 | Hood | each |
| X716860 | 62-65 | Hood (cowl induction)(steel) | each |
| X716800 | 66-67 | Hood | each |
| X716850 | 66-67 | Hood (cowl induction)(steel) | each |
| X717100 | 68-72 | Hood (standard & SS) | each |
| X717150 | 68-72 | Hood (cowl induction)(steel) | each |



X716860



X717100

FRONT FENDERS

| | | | |
|---------|-------|----------------------|------|
| X700200 | 62-65 | Front fender (left) | each |
| X700210 | 62-65 | Front fender (right) | each |
| X701000 | 66 | Front fender (left) | each |
| X701010 | 66 | Front fender (right) | each |
| X701050 | 67 | Front fender (left) | each |
| X701060 | 67 | Front fender (right) | each |
| X701100 | 68-69 | Front fender (left) | each |
| X701150 | 68-69 | Front fender (right) | each |
| X701200 | 70-74 | Front fender (left) | each |
| X701250 | 70-74 | Front fender (right) | each |



X700200



X701010



X701250

FRONT FENDER PATCH PANELS

| | | | |
|---------|-------|---|------|
| X701500 | 66-67 | Front fender (left rear lower, 12" high) | each |
| X701510 | 66-67 | Front fender (right rear lower, 12" high) | each |
| X701520 | 68-74 | Front fender (left rear lower, 12" high) | each |
| X701530 | 68-74 | Front fender (right rear lower, 12" high) | each |
| X701540 | 75-79 | Front fender (left rear lower, 12" high) | each |
| X701550 | 75-79 | Front fender (right rear lower, 12" high) | each |



X701500



X701520

1962 – 1979 Nova & Acadian Catalogue Volume 9

PHONE: (905)627-4527 ORDERS 1-866-767-2787 FAX (905)627-3210



Sheet Metal Parts

FRONT INNER FENDERS

| | | | |
|-----------|-------|--------------------------------------|-------|
| *X701400A | 62-67 | Shock tower & apron assembly (left) | each |
| *X701400B | 62-67 | Shock tower & apron assembly (right) | each |
| *X701405A | 62-67 | Shock tower (left, 3 pieces) | SOON! |
| *X701405B | 62-67 | Shock tower (right, 3 pieces) | SOON! |
| *X701410 | 62-67 | Shock tower cap | each |
| *X701415 | 62-67 | Spring upper seat | each |
| *X701420A | 62-67 | Outer shock tower panel (left) | each |
| *X701420B | 62-67 | Outer shock tower panel (right) | each |
| X701450 | 68-74 | Front inner fender (left) | each |
| X701452 | 68-74 | Front inner fender (right) | each |

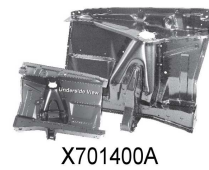

RADIATOR SUPPORTS

| | | | |
|----------|-------|-------------------------------------|------|
| X702050B | 66-67 | Radiator support | each |
| X702100 | 68-74 | Radiator support (except big block) | each |
| X702105 | 68-74 | Radiator support (big block) | each |



DOORS

| | | | |
|-----------|-------|--------------------|------|
| X704000 | 62-65 | Door skin (left) | each |
| X704010 | 62-65 | Door skin (right) | each |
| X704050 | 66-67 | Door skin (left) | each |
| X704060 | 66-67 | Door skin (right) | each |
| X704065A | 67 | Door shell (left) | each |
| X704065B | 67 | Door shell (right) | each |
| *X704070A | 66 | Door Shell (left) | each |
| *X704070B | 66 | Door shell (right) | each |
| X704100 | 68-74 | Door skin (left) | each |
| X704110 | 68-74 | Door skin (right) | each |



REAR QUARTERS

| | | | |
|---------|-------|--|------|
| X705600 | 62-65 | Rear wheel flair panel (left)(6" x 36") | each |
| X705650 | 62-65 | Rear wheel flair panel (right)(6" x 36") | each |
| X705750 | 66-67 | Rear wheel flair panel (left)(5" x 36") | each |
| X706000 | 66-67 | Rear wheel flair panel (right)(5" x 36") | each |
| X706500 | 62-65 | Lower rear quarter (left)(9" x 29") | each |
| X706550 | 62-65 | Lower rear quarter (right)(9" x 29") | each |
| X707400 | 62-65 | Rear quarter panel skin (left) | each |
| X707410 | 62-65 | Rear quarter panel skin (right) | each |
| X707420 | 62-65 | Rear quarter panel (OE style)(left) | each |
| X707425 | 62-65 | Rear quarter panel (OE style)(right) | each |
| X707450 | 66-67 | Rear quarter panel (OE style)(left) | each |
| X707460 | 66-67 | Rear quarter panel (OE style)(right) | each |
| X707500 | 66-67 | Rear quarter panel skin (left) | each |
| X707600 | 66-67 | Rear quarter panel skin (right) | each |
| X707700 | 68-69 | Rear quarter panel skin (left) | each |
| X707710 | 68-69 | Rear quarter panel skin (right) | each |
| X707720 | 68-69 | Rear quarter panel with sails(left) | each |
| X707725 | 68-69 | Rear quarter panel with sails(right) | each |
| X707800 | 70-72 | Rear quarter panel skin (left) | each |
| X707810 | 70-72 | Rear quarter panel skin (right) | each |
| X707820 | 70-72 | Rear quarter panel with sails(left) | each |
| X707825 | 70-72 | Rear quarter panel with sails(right) | each |
| X707850 | 73-74 | Rear quarter panel skin (left) | each |
| X707860 | 73-74 | Rear quarter panel skin (right) | each |
| X707900 | 75-79 | Rear quarter panel skin (2 dr)(left) | each |
| X707920 | 75-79 | Rear quarter panel skin (2 dr)(right) | each |



1962 – 1979 Nova & Acadian Catalogue Volume 9

PHONE: (905)627-4527 ORDERS 1-866-767-2787 FAX (905)627-3210



Sheet Metal Parts

FLOOR PANS

| | | | |
|---------|-------|--|------|
| X708500 | 62-67 | Floor pan (left half) | each |
| X708750 | 62-67 | Floor pan (right half) | each |
| X708760 | 62-67 | Full floor pan (with center seam)(left) | each |
| X708770 | 62-67 | Full floor pan (with center seam)(right) | each |
| X708850 | 62-67 | Floor pan (left front) | each |
| X708900 | 62-67 | Floor pan (right front) | each |
| X708950 | 62-67 | Floor pan (left rear) | each |
| X709000 | 62-67 | Floor pan (right rear) | each |
| X709100 | 62-67 | Front floor pan brace (left) | each |
| X709210 | 62-67 | Front floor pan brace (right) | each |



X709220



X708750



X709000

| | | | |
|---------|-------|--|------|
| X709220 | 62-67 | Center floor pan brace (left) | each |
| X709230 | 62-67 | Center floor pan brace (right) | each |
| X709240 | 68-79 | Toe board (left) | each |
| X709245 | 68-79 | Toe board (right) | each |
| X709250 | 68-79 | Floor pan (left half)(Taiwan) | each |
| X709500 | 68-79 | Floor pan (right half)(Taiwan) | each |
| X709600 | 68-79 | Floor pan (left half)(US made) | each |
| X709650 | 68-79 | Floor pan (right half)(US made) | each |
| X709750 | 68-79 | Floor pan (left front) | each |
| X710000 | 68-79 | Floor pan (right front) | each |
| X710250 | 68-79 | Floor pan (left rear) | each |
| X710500 | 68-79 | Floor pan (right rear) | each |
| X710550 | 62-67 | Shifter tunnel cover | each |
| X710600 | 68-74 | Console floor hump (rear) | each |
| X710650 | 62-67 | Rear seat pan under rear seat w/bracing | EACH |
| X708400 | 62-67 | Complete floor from toeboard seam to back of rear seat, all braces installed. | each |
| X708450 | 62-67 | Full floor (4 speed) toeboard seam to back of rear seat, all braces installed. | EACH |
| X710700 | 62-67 | Complete floor & trunk pan (without shifter hole) | each |
| X710710 | 62-67 | Complete floor & trunk pan (with rocker panels, without shifter hole) | each |



X709245



X710650



X709500

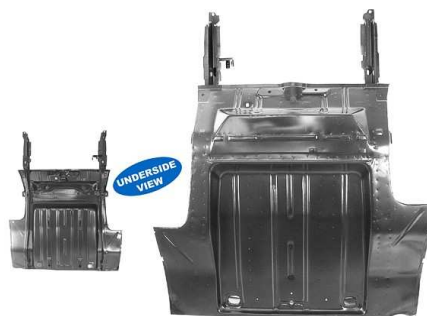
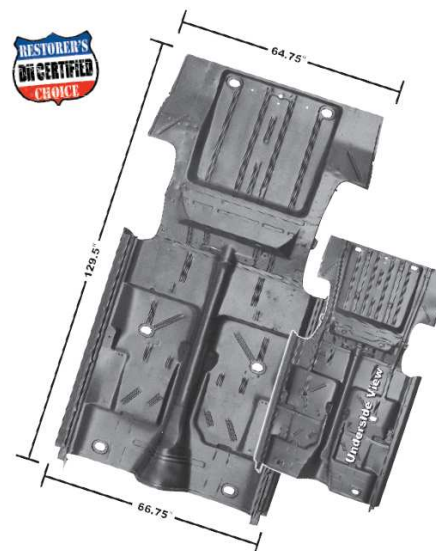

TRUNK FLOORS & RELATED

| | | | |
|---------|-------|--|------|
| X710750 | 62-67 | Trunk pan (US made) | each |
| X710760 | 62-67 | Trunk pan (Taiwan made) | each |
| X710765 | 62-67 | Full trunk pan (with gas tank braces and straps) | each |
| X710766 | 66-67 | Complete trunk & rear seat assembly (welded one piece with braces installed) | EACH |
| X711250 | 68-74 | Trunk floor (left side) | each |
| X711300 | 68-74 | Trunk floor (center)(US made) | each |
| X711305 | 68-74 | Trunk floor (center)(Taiwan)(40 x 31) | each |
| X711350 | 68-74 | Trunk floor (right side) | each |



1962 – 1979 Nova & Acadian Catalogue Volume 9

PHONE: (905)627-4527 ORDERS 1-866-767-2787 FAX (905)627-3210



Sheet Metal Parts

TRUNK SIDE FILLER PANELS

| | | | |
|---------|-------|---|------|
| X711750 | 66-67 | Trunk side filler panel (drop-off)(left) | each |
| X711760 | 66-67 | Trunk side filler panel (drop-off)(right) | each |
| X711770 | 68-74 | Trunk side filler panel (drop-off)(left) | each |
| X711780 | 68-74 | Trunk side filler panel (drop-off)(right) | each |



X711770



X711850

X711855

REAR FRAME RAILS

| | | | |
|----------|-------|----------------------------------|------|
| X711850 | 62-67 | Rear frame rail (left complete) | each |
| X711855 | 62-67 | Rear frame rail (right complete) | each |
| X711860A | 62-67 | Frame rail brace (front left) | each |
| X711860B | 62-67 | Frame rail brace (front right) | each |
| X711865A | 62-67 | Frame rail brace (rear left) | each |
| X711865B | 62-67 | Frame rail brace (rear right) | each |



X711860A



X711865B

ROCKER PANELS

| | | | |
|-----------------|--------------|--|--------------|
| X712000 | 62-67 | Rocker panel (left, 2 door) | each |
| X712010 | 62-67 | Rocker panel (right, 2 door) | each |
| X712012 | 62-67 | Rocker panel (left, 4 door) | each |
| X712013 | 62-67 | Rocker panel (right, 4 door) | each |
| X712015 | 62-67 | Rocker panel (left)(factory style) | each |
| X712016 | 62-67 | Rocker panel (right)(factory style) | each |
| X712020 | 68-79 | Rocker panel (left, 2 door) | each |
| X712030 | 68-79 | Rocker panel (right, 2DR) | each |
| *X712040 | 68-79 | Rocker panel (left, 2DR factory style) | SOON! |
| *X712050 | 68-79 | Rocker panel (right, 2DR factory style) | SOON! |



REAR WINDOW TO TRUNK PANELS

| | | | |
|---------|-------|----------------------------|------|
| X713100 | 66-67 | Rear window to trunk panel | each |
| X713110 | 68-74 | Rear window to trunk panel | each |



TAIL LAMP PANELS

| | | | |
|---------|-------|-------------------------|------|
| X713200 | 62-65 | Tail lamp panel (left) | each |
| X713250 | 62-65 | Tail lamp panel (right) | each |



X713350



X713200



X713360B

| | | | |
|----------|-------|-----------------------------|------|
| X713350 | 66-67 | Tail lamp panel (complete) | each |
| X713360A | 66-67 | Tail lamp panel (left end) | each |
| X713360B | 66-67 | Tail lamp panel (right end) | each |
| X714400 | 68-69 | Tail lamp panel | each |
| X714500 | 70-72 | Tail lamp panel | each |
| X714510 | 73-74 | Tail lamp panel | each |



X714510



1962 – 1979 Nova & Acadian Catalogue Volume 9

PHONE: (905)627-4527 ORDERS 1-866-767-2787 FAX (905)627-3210



Sheet Metal Parts

| | | | |
|----------|-------|------------------------------------|------|
| X715000 | 62-65 | Rear outer wheel house (left) | each |
| X715010 | 62-65 | Rear outer wheel house (right) | each |
| X715100 | 66-67 | Rear outer wheel house (left) | each |
| X715110 | 66-67 | Rear outer wheel house (right) | each |
| X715115A | 66-67 | Rear wheel house (complete)(left) | each |
| X715115B | 66-67 | Rear wheel house (complete)(right) | each |
| X715120 | 68-74 | Rear outer wheel house (left) | each |
| X715130 | 68-74 | Rear outer wheel house (right) | each |



X715115A



X715130

TRUNK LIDS

| | | | |
|---------|-------|-----------|------|
| X717350 | 62-64 | Trunk lid | each |
| X717400 | 65 | Trunk lid | each |
| X717450 | 66-67 | Trunk lid | each |
| X717500 | 68-72 | Trunk lid | each |



X717500



DASH REPAIR PANEL

| | | | |
|----------|-------|--|-------|
| X730000 | 68-74 | Dash repair panel (69 Camaro, will require minor modification) | each |
| X730010 | 68-74 | Dash repair panel, as X730000, but USA | EACH |
| *X720100 | 66-67 | Cowl vent grille | SOON! |
| *X720110 | 66-67 | Outer cowl panel (left) | each |
| *X720115 | 66-67 | Outer cowl panel (right) | each |
| *X720120 | 66-67 | Firewall | each |
| *X720125 | 66-67 | Firewall to floor braces | pair |
| *X740100 | 66-67 | Roof panel | each |
| *X740110 | 66-67 | Roof panel braces | set |



1962 – 1979 Nova & Acadian Catalogue Volume 9

PHONE: (905)627-4527 ORDERS 1-866-767-2787 FAX (905)627-3210



Literature

FACTORY ASSEMBLY MANUALS

These manuals are reprints of the actual factory instruction manuals and they are full of useful exploded views for that body-off restoration project.

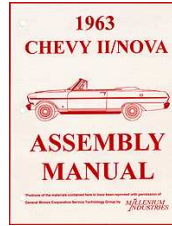
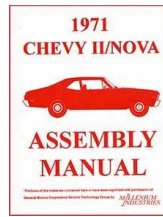
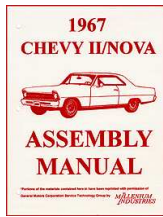

| | | | |
|---------|-------|--|------|
| XL14950 | 62-69 | Factory assembly manual (specify year) | each |
| XL14960 | 70-72 | Factory assembly manual (specify year) | each |

SHOP MANUALS

A shop manual is the single best investment you can make if you own a collectable car. They explain fully the operation, overhaul, removal, electrical, trim, glass installation, etc. Easy to understand language, full size and exactly like the original in every detail.

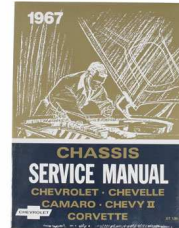
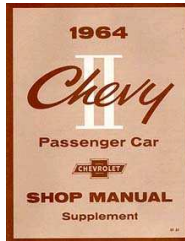

| | | | |
|---------|----|-------------------------|------|
| XL10000 | 62 | Chevy II shop manual | each |
| XL10010 | 63 | Chevy II shop manual | each |
| XL10020 | 64 | Chevy II shop manual | each |
| XL17450 | 65 | Chassis service manual | each |
| XL17460 | 65 | Chassis overhaul manual | each |
| XL17410 | 66 | Chassis service manual | each |
| XL17500 | 67 | Chassis service manual | each |
| XL17600 | 68 | Chassis service manual | each |
| XL17700 | 69 | Chassis service manual | each |
| XL17800 | 70 | Chassis service manual | each |
| XL17801 | 71 | Chassis service manual | each |
| XL17802 | 72 | Chassis service manual | each |



OWNERS MANUALS

Every car had one of these in the glove box when new.



| | | | |
|---------|-------|------------------------------|------|
| XL18100 | 64-80 | Owners manual (specify year) | each |
|---------|-------|------------------------------|------|

OTHER LITERATURE

| | | | |
|----------|-------|---|------|
| XL113410 | 66-70 | Fisher body manual (specify year) | each |
| XL200000 | 64-74 | Wiring diagram manual (specify year) | each |
| XL200100 | 64-72 | Sales brochures (specify year) | each |
| XL200105 | 67 | Super Sport sales brochure (lists all Super Sport vehicles) | each |

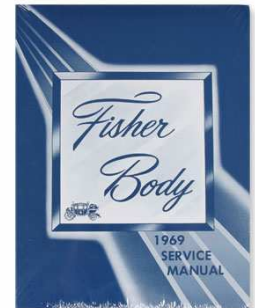

1962 – 1979 Nova & Acadian Catalogue Volume 9

PHONE: (905)627-4527 ORDERS 1-866-767-2787 FAX (905)627-3210



Interior Parts

IDIDIT TILT STEERING COLUMNS

We can now supply the popular Iddit steering columns for the X-bodies. Each are fully wired and comes equipped with 4-way flashers, self canceling turn signals, horn wiring, and the Iddit Aluminum Dress-Up kit (aluminum levers & knobs). Column shift columns also come equipped with a built in neutral safety switch as well as an automatic shift mechanism which will use the stock dash indicator. All Iddit columns use a strong 1" DD shaft and an industry standard 3 7/8" GM wiring harness connector. They are designed for use with post 1969 steering wheels or others can be used with optional adaptor.

| | | | |
|---------|-------|---|------|
| X850000 | 62-67 | Steering column (steel)(floor shift) | each |
| X850005 | 62-67 | Steering column (chrome)(floor shift) | each |
| X850010 | 62-67 | Steering column (brushed aluminum)(floor shift) | each |
| X850015 | 62-67 | Steering column (polished aluminum)(floor shift) | each |
| X850020 | 62-67 | Steering column (steel)(column shift) | each |
| X850025 | 62-67 | Steering column (chrome)(column shift) | each |
| X850030 | 62-67 | Steering column (brushed aluminum)(column shift) | each |
| X850035 | 62-67 | Steering column (polished aluminum)(column shift) | each |



X622000



X622080



X622050



X622030



X622010

STEERING WHEELS & RELATED

| | | | |
|---------|-------|--------------------------------------|------|
| X622000 | 67 | Steering wheel (deluxe) | each |
| X622005 | 67 | Deluxe wheel horn cap mounting kit | each |
| X622080 | 67 | Steering wheel (deluxe SS) | each |
| X622010 | 67-68 | Steering wheel hub (wood wheel) | each |
| X622020 | 67-68 | Wood wheel horn cap mounting kit | each |
| X622025 | 67-68 | Standard wheel horn cap mounting kit | each |
| X622030 | 69-70 | Steering wheel (black) | each |
| X622040 | 69-70 | Steering wheel shroud (black) | each |
| X622045 | 69-70 | Steering wheel horn pads (black) | pair |
| X622046 | 69-70 | Steering wheel horn contacts | pair |
| X622050 | 67-68 | Steering wheel (walnut) | each |
| X622060 | 69 | Steering wheel (rosewood) | each |
| X622070 | 69 | Steering wheel hub (wood wheel) | each |
| X107870 | 66-68 | Horn cap (wood wheel) | each |
| X107900 | 67 | Horn cap insert "SS" | each |
| X108000 | 69 | Horn shroud emblem "SS" | each |



X622025



X622045



X622040



X622046



X108000



X107870

STEERING COLUMN LEVERS

| | | | |
|---------|-------|---|------|
| X209750 | 62-66 | Turn signal lever (with knob, bolt on) | each |
| X210000 | 62-66 | Turn signal lever (w/ knob, screw in) | each |
| X210100 | 67 | Turn signal lever (with knob, with tilt wheel) | each |
| X210300 | 68-70 | Turn signal lever (with knob, with or without tilt wheel) | each |
| X210500 | 67-75 | Turn signal lever (with cruise, with knob) | each |
| X210760 | 71-74 | Turn signal lever (with knob, with or without tilt wheel) | each |
| X210800 | 63-66 | Tilt wheel release lever (with knob) | each |
| X210850 | 67 | Tilt wheel release lever (with knob) | each |
| X210870 | 68-70 | Tilt wheel release lever (with knob) | each |
| X210880 | 71-74 | Tilt wheel release lever (with knob) | each |



X210000



X210760



X210870

1962 - 1979 Nova & Acadian Catalogue Volume 9

PHONE: (905)627-4527 ORDERS 1-866-767-2787 FAX (905)627-3210



Interior Parts

SEAT COVERS

All our seat cover sets are correctly patterned and sewed precisely for an authentic factory fit. They are comprised of the most correct vinyls, backings, and welting available anywhere -- guaranteed! Please be sure to give all the necessary information when ordering, such as year, model, colour (trim number), a/c option, etc. All seat covers are vinyl except where noted.

| | | | |
|---------|-------|--|------|
| X900010 | 63-64 | Seat cover set (HT/conv)(buckets) | set |
| X900020 | 63 | Seat covers (conv. with bench) | set |
| X900030 | 63-64 | Seat cover set (2Dr sedan)(split bench) | set |
| X900040 | 63-64 | Front bucket seat covers | pair |
| X900050 | 63-64 | Front split bench seat covers | pair |
| X900060 | 63-64 | Coupe rear seat covers | pair |
| X900070 | 63-64 | Convertible rear seat covers | pair |
| X900080 | 63-64 | 2Dr sedan rear seat covers | pair |
| X900090 | 63 | Seat covers (2 door HT, cloth, bench) (these will fit the 64 bench) | set |
| X900100 | 65-67 | Seat cover set (SS HT)(buckets) | set |
| X900105 | 65-67 | Seat cover set (bench in SS style) (specify for HT or sedan) | set |
| X900110 | 66-67 | Seat cover set (HT)(non-SS bench) | set |
| X900120 | 65-67 | Seat cover set (2Dr sedan)(split bench) | set |
| X900130 | 65-67 | Front bucket seat covers | pair |
| X900140 | 66-67 | Front bench seat covers (non-SS) | pair |
| X900150 | 65-67 | Front split bench seat covers | pair |
| X900160 | 65-67 | Coupe rear seat covers (SS) | pair |
| X900170 | 65-67 | Coupe rear seat covers (non-SS) | pair |
| X900180 | 65-67 | 2Dr sedan rear seat covers | pair |
| X900190 | 66 | Seat covers (2 door HT, cloth, bench) | set |
| X900200 | 68-71 | Seat cover set (2 door)(buckets) | set |
| X900210 | 68-71 | Seat cover set (2 door)(bench) | set |
| X900220 | 68-71 | Front bucket seat covers | pair |
| X900230 | 68-71 | Front bench seat covers | each |
| X900240 | 68-71 | Coupe rear seat covers | pair |
| X900250 | 72 | Seat cover set (2 door)(buckets) | set |
| X900260 | 72 | Seat cover set (2 door)(bench) | set |
| X900270 | 72 | Front bucket seat covers | pair |
| X900280 | 72 | Front bench seat covers | each |
| X900290 | 72 | Coupe rear seat covers | pair |
| X900300 | 73-74 | Seat cover set (custom hatchback) (buckets) | set |
| X900310 | 73-74 | Front bucket seat covers | pair |
| X900320 | 75-79 | Seat cover set (buckets) | set |
| X900330 | 75-79 | Seat cover set (bench) | set |
| X900340 | 75-79 | Rear hatchback seat cover | each |

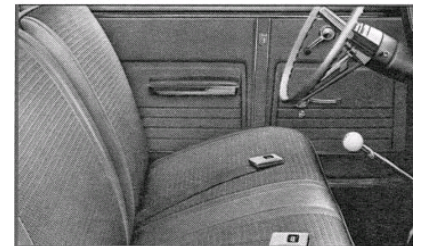
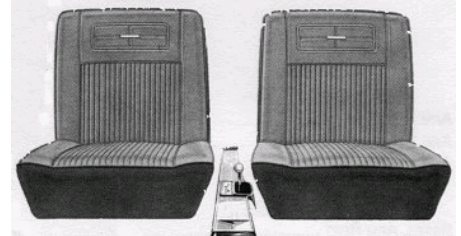

2 & 4 DOOR SEDAN & 4 DOOR WAGON SEAT COVERS

Finally, the wait for the 4 doors is over with the introduction of the 1962 to 1967 Nova 4 door sedan and wagon seat covers. As the original seat covers had a cloth insert, many times unique only for the Novas, P.U.I. had to compromise by re-styling the seat covers using the SS dielectric inserts in place of the cloth. Please specify year, model and colour when ordering.

| | | | |
|---------|-------|--|-----|
| X905400 | 62-67 | Straight front bench seat cover (4 door sedan & wagon) | set |
| X905440 | 62-67 | 4 door sedan rear seat cover | set |
| X905460 | 62-67 | 4 door wagon rear seat cover | set |

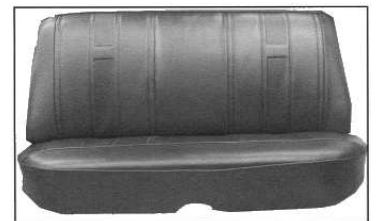

SEAT COVER INSTALLATION KIT

The seat cover installation kit includes hog ring pliers and enough hog rings (approximately 40) to install a seat kit cover set.

| | | | |
|---------|-------|--|------|
| X616750 | 62-72 | Seat cover installation kit (hog rings, each pliers, & instructions) | each |
| X616760 | 62-72 | Seat cover installation kit (hog rings, kit pliers)(better quality, knuckle friendly!) | each |
| X616770 | ALL | Hog rings, pack of 60, if more required | KIT |



1962 – 1979 Nova & Acadian Catalogue Volume 9

PHONE: (905)627-4527 ORDERS 1-866-767-2787 FAX (905)627-3210



Interior Parts



X222000



X222010



X222015

BUCKET SEAT COMPONENTS

| | | | |
|---------|-------|--|------|
| X221750 | 68-72 | Seat adjustment knob | each |
| X222000 | 62-64 | Bucket seat retaining cap | pair |
| X222005 | 69 | Bucket seat headrest lock assembly | each |
| X222010 | 70-71 | Bucket seat headrest lock assembly | each |
| X222015 | 67-68 | Bucket seat back button | each |
| X222020 | 69-71 | Bucket seat back button | each |
| X917000 | 66-67 | Bucket seat trim mouldings (chrome) | set |
| X917100 | 66-67 | Bucket seat trim end caps (set of 12) | set |
| X917200 | 66-67 | Bucket seat trim mouldings & caps | set |
| X917500 | 62-65 | Bucket seat foam (moulded)(1 seat) | each |
| X917510 | 66-67 | Bucket seat foam (moulded)(1 seat) | each |
| X917600 | 66-71 | Bucket seat back panels (black) | pair |
| X917620 | 68-71 | Bucket seat back panels (all colours) | pair |
| X917640 | 68-71 | Bucket seat trim (with moulding)(around lower seat cushion)(black)(2 seats) | set |
| X917660 | 68-71 | Bucket seat trim (with moulding)(around lower seat cushion)(specify colour)(2 seats) | set |
| X917680 | 68-71 | Bucket seat trim kits (2 backs and 4 bottoms assembled with chrome trim & bullet ends installed)(black only) | kit |
| X917700 | 68-71 | Bucket seat trim kits (2 backs and 4 bottoms assembled with chrome trim & bullet ends installed)(specify colour) | kit |
| X918000 | 68-72 | Headrest covers (in matching interior colours)(specify buckets or bench) | pair |
| X918002 | 73-74 | Bench headrest covers (specify colour) | pair |
| X918004 | 75-79 | Bench headrest covers (specify colour) | pair |
| X918010 | 66-67 | Headrest assemblies (black) | pair |
| X918020 | 69 | Headrest assemblies (black) | pair |
| X918030 | 70-71 | Headrest assemblies (black) | pair |



X917000



X222020



SIDE PANELS

Our side panel kits come unassembled. These are the most correct dielectrically pressed panels on the market. The correct vinyls are heat sealed to new boards and proper emblems or buttons are attached on most models. During installation is a good time to replace worn windowfelts (fuzzies). The side panel kit prices below are for full sets; unassembled side panel kits for front doors only are available: please phone or fax for prices. All are for 2 door models unless specified otherwise.

| | | | |
|---------|-------|--|------|
| X906300 | 62-68 | Side panel kit (all 2dr)(set of 4) | set |
| X906310 | 62-68 | Side panels (doors only) | pair |
| X906350 | 63-72 | Side panel set (4 door sedan & wagons) (specify year and colour) | set |
| X906400 | 69-72 | Side panel kit(specify year & colour) | set |
| X909500 | 68-72 | Side panel kit (fully assembled for easy installation)(includes plastic top rail, inner windowfelt and lock knob ferrules) | set |
| X909600 | 73-74 | Side panels (Custom)(black only) | pair |
| X909610 | 75-78 | Side panels (specify colour) | pair |



ARM RESTS

| | | | |
|---------|-------|---|------|
| X311490 | 62-64 | Arm rests pads (specify year & colour, front or rear) | pair |
| X311750 | 65-67 | Arm rest pad (front, colours) | pair |
| X312000 | 68-72 | Arm rest pad (specify colour) | pair |
| X219250 | 62-64 | Arm rest bases (front, chrome) | pair |
| X219300 | 62-64 | Arm rest bases (rear, chrome) | pair |



X311750

1962 – 1979 Nova & Acadian Catalogue Volume 9

PHONE: (905)627-4527 ORDERS 1-866-767-2787 FAX (905)627-3210



Interior Parts



X219500

| | | | |
|---------|-------|--|------|
| X219500 | 65-67 | Arm rest bases (front) | pair |
| X420000 | 68-72 | Arm rest base (left)(specify colour) | each |
| X420100 | 68-72 | Arm rest base (right)(specify colour) | each |
| X420110 | 68-72 | Arm rest bases & pads (black) | pair |
| X420120 | 68-72 | Arm rest bases & pads (specify colour) | pair |
| X921000 | 63 | Rear arm rest covers (conv.) | set |



X420000



X223800

| | | | |
|------------------|-------|---|------|
| <u>ASH TRAYS</u> | | | |
| X223500 | 62-63 | Ash tray (with bezel, rear arm rest, convertible) | each |
| X223750 | 62-67 | Ash tray (rear quarter, Chevy II only) | each |
| X223800 | 62-67 | Ash tray (rear, 2 door, hardtop) | pair |
| X224000 | 70-72 | Ash tray (rear arm rest) | each |

DOOR LOCK KNOBS

| | | | |
|---------|-------|--|------|
| X220900 | 62-66 | Door lock knobs (chrome or colours) | pair |
| X221000 | 67 | Door lock knobs (chrome or colours) | pair |
| X221250 | 68-70 | Door lock knobs (chrome or colours) (ribbed shank) | pair |
| X221260 | 71-79 | Door lock knobs (chrome, smooth) | pair |
| X409400 | 62-67 | Door lock knob ferrules | pair |
| X221500 | 68-75 | Door lock knob ferrules | pair |



HEADLINERS

There are many variations of headliners available on the market today. Look at your existing headliner to determine the type of cloth or vinyl used. When an exact pattern of material is no longer available, a similar suitable replacement material will be used. Most factory colours are available. Sunvisor and rear quarter sail material is included for the hardtops and sedans. Available in most factory colours and in basketweave, tier weave, or Impala leather. **Note:** Specify year, model & colour when ordering!

| | | | |
|---------|-------|---|------|
| X910000 | 62-72 | Headliner (basketweave/ tier weave/ Impala leather)(with covered sail panels) | each |
| X910010 | 73-79 | Headliner ABS plastic shell | each |
| X910020 | 73-79 | Headliner assembly (foam backed velour glued to an ABS plastic shell) | each |
| X910030 | 73-79 | Headliner assembly (foam backed vinyl glued to an ABS plastic shell) | each |



HEADLINER BOWS

| | | | |
|---------|-------|---------------------------------------|-------|
| X911300 | 62-72 | Headliner bows (specify year & model) | set |
| X911310 | 68-72 | Headliner bow clips | set/6 |



SUNVISORS

| | | | |
|---------|-------|----------------------------------|------|
| X911150 | 62-74 | Sunvisors (specify year, colour) | pair |
| X911160 | 75-79 | Sunvisors (specify year, colour) | pair |
| x911180 | 62-74 | Sunvisor tips & bushings | set |
| X225250 | 62-64 | Sunvisor brackets | pair |
| X225500 | 65-72 | Sunvisor bracket (hardtop) | each |

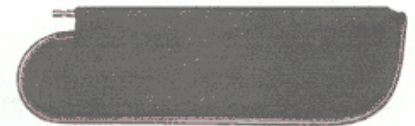

1962 – 1979 Nova & Acadian Catalogue Volume 9

PHONE: (905)627-4527 ORDERS 1-866-767-2787 FAX (905)627-3210

Interior Parts

| | | | |
|---------|-------|---|------|
| X911010 | 62-67 | Front inside window trim (upper)(black) | each |
| X911020 | 62-65 | Rear inside window trim (H.T.)(5 pc) | set |
| X911050 | 66-67 | Rear inside window trim (HT)(black) (H.T., black)(lower corners) | pair |
| X911075 | 66-67 | Rear inside window trim (HT)(black) (H.T., black)(upper corners) | pair |
| X911100 | 66-67 | Rear inside window trim (sides/upper) (7pc)(black) | set |
| X911110 | 66-67 | Rear inside window trim (HT)(7 pc) | set |
| X911120 | 66-67 | Rear inside window trim (sedan)(3 pc) | set |

WINDLACE END CAPS

| | | | |
|---------|-------|---------------------------|------|
| X409150 | 62-67 | Windlace end caps (black) | pair |
|---------|-------|---------------------------|------|

COAT HOOKS & BELT HOOKS

| | | | |
|---------|-------|---|------|
| X225000 | 62-66 | Interior coat hooks (chrome) | pair |
| X225010 | 67-79 | Interior coat hooks (black plastic) | PAIR |
| X225020 | 68-72 | Shoulder belt roof hooks, original item | PAIR |



CARPETS

We now have two reliable sources for carpets. Between both our suppliers we can supply carpets for most cars and trucks from 1949 right into the 90's! Materials and colours are available to match almost any vehicle's interior. These carpets are factory moulded and come with the jute backing and sewn in heel-pad.

Don't forget to order a carpet for your newer car or truck, too. Why drive every day in a shabby environment?

| | | | |
|---------|-------|-------------------------------------|-----|
| X911450 | 62-67 | Carpet (factory moulded, any model) | set |
| X911800 | 68-74 | Carpet (factory moulded, any model) | set |
| X911810 | 75-79 | Carpet (factory moulded, any model) | set |
| X912815 | 62-67 | Floor insulation kit | set |
| X912830 | 68-79 | Floor insulation kit | set |



DOOR SILL PLATES

| | | | |
|---------|-------|---|------|
| X217200 | 62-67 | Door sill plates (2 door)(nice) | pair |
| X217250 | 62-67 | Door sill plates (2 door)(better) | pair |
| X217300 | 62-63 | Door sill plates (conv) | pair |
| X217400 | 62-67 | Door sill plates (4 door sedan & wagon) | set |
| X217800 | 68-79 | Door sill plates (reproduction) | pair |
| A256250 | 64-72 | Door sill plate emblem (self sticking) | each |



CONVERTIBLE ITEMS

We buy our tops from ACME Auto Headlining Company. ALL manufacturers fabricate from the same source of materials (usually vinyls extruded onto cloth backing). The weight of the materials is consistent throughout the aftermarket industry. ALL glass windows come from the same source.

| | | | |
|---------|-------|--|------|
| X912900 | 62-63 | Convertible top (with window and pads, black or white) | set |
| X913500 | 62-63 | Convertible top well (black) | each |
| X913750 | 62-63 | Convertible top boot (in matching interior colours) | each |
| X225700 | 62-63 | Convertible top latches | pair |
| X225900 | 62-63 | Convertible top latch bushings | pair |
| X913800 | 62-63 | Convertible tension cables | pair |
| X913810 | 62-63 | Convertible top hoses (with fittings) | set |
| X913820 | 62-63 | Convertible top cylinder | each |
| X913830 | 62-63 | Convertible top motor/pump assembly | each |



CAR COVERS

1962 – 1979 Nova & Acadian Catalogue Volume 9

PHONE: (905)627-4527 ORDERS 1-866-767-2787 FAX (905)627-3210

Interior Parts

Here's an exterior item you should keep in the trunk when you are not using it. Like any valuable investment, your Nova will benefit greatly from a little extra care and protection. This Evolution car cover represents the finest on the market in terms of practicality, durability, appearance and value. This is one of the most rain resistant and breathable car covers on the market. Each cover is produced using high quality Polypropylene Evolution 4 fabric from Kimberly Clark. A high tech 4 layer fabric, Evolution is lightweight, remains pliable in all weather conditions and won't rot, smell, or mildew. The outside and inside layers are made of long fibers which make the fabric tough but very soft and non abrasive. The middle layer is made of shorter fibers that catch water but allow the air to circulate. Also includes double stitched seams with an elastic band in the front and rear making installation easy! Specially developed for harsh outside weather conditions and will not freeze even in the coldest temperatures. Each cover is water resistant and breathes keeping your paint free from unwanted moisture between the paint and the car cover which could ruin your paint.



 **EVOLUTION⁴**
CAR COVER FABRIC



| | | | |
|---------|-------|--------------------------------------|------|
| X999000 | 62-67 | Car cover, 4 layer outdoor or indoor | EACH |
| X999100 | 68-79 | Car cover, 4 layer outdoor or indoor | EACH |

VINYL TOPS

Seems out of place in the interior section, but that's where other catalogues list them. Our vinyl tops, or Landau tops are made with the correct Levant grain vinyl and sewn with Dacron bonded thread, dielectrically double seamed to give it the correct appearance. Available in black, white, buckskin, green and the custom colour, dark blue. Available for **MOST** models. Please specify year, colour and model when ordering.

| | | | |
|---------|-------|-------------------------------------|------|
| X914100 | 62-74 | Vinyl (landau) top (black or white) | each |
| X914110 | 62-74 | Vinyl (landau) top (specify colour) | each |
| X914120 | 75-79 | Vinyl (landau) top (black or white) | each |
| X914130 | 75-79 | Vinyl (landau) top (specify colour) | each |



PACKAGE TRAYS & INSULATION

The package tray is often sun-baked or water stained over the years as it is the piece between the rear window and rear seat. It features coloured textured cardboard and a vinyl strip that matches the interior colour. Available in most original interior colours and available for hardtop models only. Please specify year & colour when ordering. Keep in mind when shipping a package tray, it is as expensive as the tray itself. It is recommended to get the rear seat to trunk board at the same time to save on shipping.

| | | | |
|---------|-------|--|------|
| X914600 | 62-65 | Rear package tray (2 door, H.T./sedan) | each |
| X914800 | 66-67 | Rear package tray (2 door, H.T.) | each |
| X915000 | 68-72 | Rear package tray (2 door) | each |
| X915200 | 68-72 | Package tray corners | pair |
| X916000 | 62-72 | Package tray insulation (specify year) | each |



1962 – 1979 Nova & Acadian Catalogue Volume 9

PHONE: (905)627-4527 ORDERS 1-866-767-2787 FAX (905)627-3210



Interior Parts

REAR SEAT TO TRUNK BOARDS & INSULATION

Often called a trunk divider, the rear seat to trunk board is the panel that finishes off the trunk area by hiding the seat springs from sight. Available for most models. Please specify year and model when ordering. It is recommended to get the package tray at the same time to save on shipping.

| | | | |
|---------|-------|--|------|
| X916100 | 62-72 | Rear seat to trunk board (specify year) | each |
| X916200 | 62-72 | Rear seat to trunk board insulation (specify year) | each |

KICK PANELS

| | | | |
|---------|-------|--|------|
| X920000 | 62-65 | Kick panels (black, red, blue, aqua, saddle, fawn) | pair |
|---------|-------|--|------|

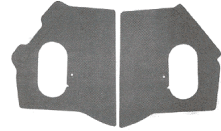

DASH PADS

| | | | |
|---------|-------|--|------|
| X930100 | 66 | Dash pad (black) | each |
| X930150 | 67 | Dash pad (black) | each |
| X930160 | 68 | Dash pad (black) | each |
| X930180 | 69-72 | Dash pad (specify air, black) (will also fit 73, 74) | each |



GLOVE BOX LINERS

| | | | |
|---------|-------|--|------|
| X603500 | 62-65 | Glove box liner | each |
| X603750 | 66-67 | Glove box liner | each |
| X604000 | 68-72 | Glove box liner (with air cond.) (specify year) | each |
| X604250 | 68-72 | Glove box liner (without air cond.) (specify year) | each |



FIREWALL PADS

| | | | |
|---------|-------|--|------|
| X615250 | 62-67 | Firewall pad, exact cardboard, w/rubber bottom flap sewn on as original. 5 piece | each |
| X615270 | 62-67 | Firewall pad, replacement. (rubber, jute) | EACH |
| X615300 | 68-74 | Firewall pad (without air conditioning) (with clips) | each |
| X615350 | 68-74 | Firewall pad (with air conditioning) (with clips) | each |
| X615400 | 62-74 | Firewall pad retainer | each |



TRUNK MATS

| | | | |
|---------|-------|-------------------|------|
| X617750 | 62-66 | Trunk mat (vinyl) | each |
| X618000 | 67 | Trunk mat (vinyl) | each |
| X618500 | 68-72 | Trunk mat (vinyl) | each |

INTERIOR HANDLES

| | | | |
|---------|-------|---|------|
| X207700 | 62-64 | Window crank (double arm, black knob) (except Chevy II) | each |
| X207710 | 62-64 | Window crank (single arm, black knob) (Chevy II only) | each |
| X207720 | 65-66 | Window crank (black knob) | each |
| X207730 | 67 | Window crank (black knob) | each |
| X207750 | 68-79 | Window crank (with black knob) | each |
| X208000 | 69-75 | Window crank (with clear knob) | each |
| X208200 | 62-65 | Interior door handle (double arm) | each |



X207700

X207710



X208200



X208500



X208000

| | | | |
|---------|-------|---------------------------------------|------|
| X208250 | 63-65 | Door handle (interior, Chevy II only) | each |
| X208500 | 65-67 | Door handle (interior) | each |
| X208700 | 68-74 | Door handle (standard interior) | each |
| X208750 | 68-72 | Door handle (deluxe interior, left) | each |
| X209000 | 68-72 | Door handle (deluxe interior, right) | each |
| X409500 | 62-79 | Door handle/window crank washer | each |



X209505

1962 – 1979 Nova & Acadian Catalogue Volume 9

PHONE: (905)627-4527 ORDERS 1-866-767-2787 FAX (905)627-3210

Interior Parts

| | | | |
|---------|-------|---------------------|------|
| X209505 | 62-67 | Vent window handles | pair |
| X209550 | 68-72 | Vent window handles | pair |

INTERIOR MIRRORS

| | | | |
|---------|-------|--------------------------------------|------|
| X216800 | 62-67 | Rear view mirror (not day/night) | each |
| X216850 | 62-72 | Rear view mirror (day/night)(8") | each |
| X216900 | 62-67 | Rear view mirror (day/night)(10") | each |
| X216950 | 62-65 | Rear view mirror bracket (2 door HT) | each |
| X216960 | 66-67 | Rear view mirror bracket (2 door HT) | each |
| X216990 | 67-72 | Vanity visor mirror | each |



DOME LAMPS

| | | | |
|---------|-------|-----------------|------|
| X219750 | 62-70 | Dome lamp bezel | each |
| X220000 | 71-75 | Dome lamp bezel | each |
| X402500 | 62-70 | Dome lamp lens | each |
| X402750 | 71-79 | Dome lamp lens | each |



INTERIOR EMBLEMS

| | | | |
|---------|-------|---------------------------------------|------|
| X103650 | 63-64 | Glove box emblem "Nova" | each |
| X103750 | 63-64 | Glove box emblem "Nova SS" | each |
| X104000 | 66 | Glove box emblem "SS" | each |
| X104250 | 66 | Glove box emblem (standard) | each |
| X104400 | 67 | Lower dash emblem "Nova" | each |
| X104450 | 67 | Glove box emblem "Super Sport" | each |
| X107750 | 66-67 | Door panel emblems (crest) | pair |
| X107770 | 69-72 | Door panel emblems "Nova" | pair |
| X107850 | 66-67 | Seat back emblems (set of 4, Nova SS) | set |
| X108100 | 68-69 | Console emblem "Nova" | each |



CONSOLE GAUGES

| | | | |
|----------|-------|--------------------------------|------|
| X404000 | 68-74 | Console oil gauge | each |
| X404010A | 68-74 | Console oil gauge line (white) | each |
| X404010B | 68-74 | Console oil gauge line (black) | each |



X404000

X509250

X509260

X509265

| | | | |
|---------|-------|--|------|
| X509250 | 68-74 | Console temperature gauge | each |
| X509260 | 68-74 | Console fuel gauge | each |
| X509265 | 68-74 | Console battery gauge | each |
| X405260 | 68-74 | Console gauge lens (2 per console) | each |
| X405270 | 68-74 | Console gauge cover w/ silver trim | each |
| X405280 | 68-72 | Console gauge base | each |
| X405290 | 68-72 | Console gauge bezel (fuel/oil) | each |
| X405300 | 68-72 | Console gauge bezel (battery/temp.) | each |
| X405340 | 68-74 | Console gauge mounting plate (batt/temp) | EACH |
| X405345 | 68-74 | Console gauge mounting plate (fuel/oil) | EACH |
| X405350 | 68-74 | Connector kit, included in gauge package | KIT |
| X405355 | 68-74 | Console gauge screw kit, incl in package | KIT |
| X520270 | 68-74 | Console gauge harness (factory gauges) | each |



X405280

X405340



X405290
X405350

CONSOLE GAUGE PACKAGE

Now it is easy to add or replace the console gauge assembly to your restoration. Simply plug into the existing console wiring harness or add the harness to the order.

| | | | |
|---------|-------|---|-----|
| X405400 | 68-74 | Console gauge pre-assembled package kit | KIT |
|---------|-------|---|-----|

CONSOLES & RELATED



1962 – 1979 Nova & Acadian Catalogue Volume 9

PHONE: (905)627-4527 ORDERS 1-866-767-2787 FAX (905)627-3210



Interior Parts

| | | | |
|---------|-------|--|------|
| X404250 | 64-72 | Console slider (with auto trans.) | each |
| X404500 | 65-67 | Console slider (with 4 speed) | each |
| X404750 | 68-72 | Console slider (with 4-speed) | each |
| X404900 | 66-67 | Console shift indicator lens (powerglide) | each |
| X405000 | 68-72 | Console indicator lens (with powerglide) | each |
| X405250 | 68-72 | Console indicator lens (with turbo-hydromatic transmission) | each |
| X405310 | 68-72 | Console (plastic shell only) | each |
| X405320 | 68-74 | Console cover (front) (use if no gauges) | each |
| X405330 | 68-72 | Console shift plate slider bracket (4-speed or automatic transmission) | each |
| X316780 | 64-67 | Shift boot (4 speed) w/or w/o console | each |
| X316785 | 64-67 | Shift boot retainer (4 speed)(w/or w/o) | each |
| X403800 | 68-74 | Shift plate assembly (standard, 1 pc) | EACH |
| X403810 | 68-74 | Shift plate assembly (automatic, 2 pc) | SET |
| X317000 | 68-72 | Shift boot (lower, with standard transmission and console) | each |
| X317040 | 68-72 | Shift boot retainer (4 sp with console) | each |
| X317100 | 68-74 | Shift boot (auto floor shift) | each |
| X408850 | 63-64 | Shift knob (63 "SS", 64 "SS" Powerglide) | each |
| X408900 | 64-67 | Floor shift lever release button (with auto transmission) | each |
| X409000 | 67-75 | Shift knob (on column, replacement) | each |
| X409020 | ALL | Chrome shift ball, 5/16" thread | EA |
| X409030 | ALL | Chrome shift ball 3/8" thread | EA |
| X409050 | 65-68 | Shift knob (4-speed, white, 5/16" thread) | each |
| X409060 | 69-72 | Shift knob (4-speed, white, 3/8" thread) | each |



68-72 SHIFT BOOT & RETAINER (WITHOUT CONSOLE)

| | | | |
|---------|-------|---|------|
| X317020 | 68-72 | Shift boot ring & retainer (except console) | set |
| X317030 | 68-72 | Shift boot (4 speed, without console) | each |

DASH RELATED TRIM

| | | | |
|---------|-------|--|-------|
| X408750 | 62-66 | Shift knob (on column) | each |
| X409070 | 67 | Radio knobs | pair |
| X409090 | 67 | Light switch knob & shaft | each |
| X409190 | 69-70 | Light switch knob | each |
| X409195 | 72-75 | Light switch knob & shaft | each |
| X239000 | 65 | Dash trim set (SS, 5 pcs) | set |
| X239100 | 65 | Dash trim set (Nova, 5 pcs) | set |
| X239110 | 65 | Dash bezel | each |
| X239115 | 65 | Dash bezel lens | each |
| X440040 | 66 | Dash bezel | each |
| X440045 | 67 | Dash bezel | each |
| X440050 | 66-67 | Dash bezel lens | each |
| X440051 | 66-67 | Dash knob bezel set | each |
| X440065 | 68-76 | Dash lens | each |
| X409100 | 62-67 | Park brake handle | each |
| X409120 | 68-74 | Park brake handle | each |
| X409200 | 69 | Radio tone control knobs (specify mono or stereo) | pair |
| X409210 | 69 | Radio knobs (mono or stereo) | pair |
| X409220 | 71-75 | Heater control lever knobs (specify chrome or black) | set/4 |
| X409750 | 68-75 | Seat adjustment knob (black, replacement) | each |
| X240000 | 66-67 | Radio bezel (chrome, edges painted) | each |
| X409310 | 65-66 | Cigarette lighter (Rochester element) | each |
| X409315 | 67 | Cigarette lighter | each |
| X409320 | 69 | Cigarette lighter | each |
| X409325 | 70-77 | Cigarette lighter | each |
| X406250 | 68-75 | Dash air outlet deflector (with air conditioning, black) | each |

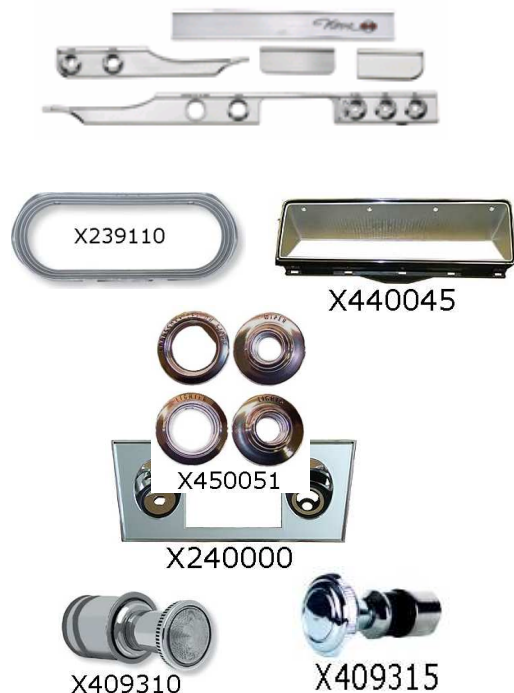

1962 – 1979 Nova & Acadian Catalogue Volume 9

PHONE: (905)627-4527 ORDERS 1-866-767-2787 FAX (905)627-3210

Interior Parts

SEAT BELTS

Protecting you classic is a good idea, but don't forget about protecting the passengers and driver! Whether the vehicle had them or not, it is generally a great idea to install or replace worn-out and faded seat belts with these new replacement style seat belts, even if it is only for safety sake. These lap belts are a replacement for the 1955 - 1957, but will look good in any vehicle. Many people have commented on these to look similar to seat belts found on airplanes. Hardware is also included. Generally, 74" is used in the fronts and 60" in the rear seats. When in doubt, give us the trim number and we'll match up a colour for you. **Note** - a pair is enough for two people.

| | | |
|---------|-------------------------------|------|
| D929010 | Seat belt (74")(black) | pair |
| D929020 | Seat belt (60")(black) | pair |
| D929030 | Seat belt (74")(flame red) | pair |
| D929040 | Seat belt (60")(flame red) | pair |
| D929050 | Seat belt (74")(red) | pair |
| D929060 | Seat belt (60")(red) | pair |
| D929070 | Seat belt (74")(saddle/brown) | pair |
| D929080 | Seat belt (60")(saddle/brown) | pair |
| D929090 | Seat belt (74")(fawn/tan) | pair |
| D929100 | Seat belt (60")(fawn/tan) | pair |
| D929110 | Seat belt (74")(blue) | pair |
| D929120 | Seat belt (60")(blue) | pair |
| D929130 | Seat belt (74")(dark blue) | pair |
| D929140 | Seat belt (60")(dark blue) | pair |
| D929150 | Seat belt (74")(turquoise) | pair |
| D929160 | Seat belt (60")(turquoise) | pair |
| D929170 | Seat belt (74")(bright blue) | pair |
| D929180 | Seat belt (60")(bright blue) | pair |
| D929190 | Seat belt (74")(silver) | pair |
| D929200 | Seat belt (60")(silver) | pair |
| D929210 | Seat belt (74")(green) | pair |
| D929220 | Seat belt (60")(green) | pair |
| D929230 | Seat belt (74")(ivory) | pair |
| D929240 | Seat belt (60")(ivory) | pair |
| D929250 | Seat belt (74")(white) | pair |
| D929260 | Seat belt (60")(white) | pair |
| D929270 | Seat belt (74")(dark green) | pair |
| D929280 | Seat belt (60")(dark green) | pair |



1962 – 1979 Nova & Acadian Catalogue Volume 9

PHONE: (905)627-4527 ORDERS 1-866-767-2787 FAX (905)627-3210



RetroSound™

Modern Sound for your Classic

This is a breakthrough classic car radio offering flexible mounting options with infiniMount shaft/bracket system (patent pending), USB input for MP3/WMA digital file playback from popular flash devices, this is awesome-- no iPod needed, use ANY Flash Drive/Thumb drive with your digital files on it!!!, There's even a front panel Auxiliary input so you can plug in any device you want too!!, Remote control and hideaway installation capability. The Model One was created to meet the needs of classic car enthusiasts for a radio that maintains the classic in dash look of the vehicle while offering modern playback capabilities from today's digital music sources. An optional 94" remote mount infrared "eye" allows for complete hideaway placement of the Model One, allowing a completely stock appearance. Any car, RV, motorcycle! Modify the faceplate and the radio Not your dash! The included U Bracket allows for under dash mounting options and the unit can be mounted virtually anywhere due to its small 3.54" w X 6.57" d X 1.57" h footprint. Advanced installers can unscrew the Model One's faceplate and adjust its cant/angle to allow for even more customization! There are multiple faceplate & knob kits available, and RetroSound even offers a Universal faceplate that fits the Model One's faceplate which allows the installer to use the integrated break away tabs to modify all aspects of height & width of the plate, and even drill in their own shaft holes to fit virtually any car! This radio is a true problem solver for tough to fit applications, its unique bracket system combined with small mounting size and incredible feature set is setting the classic radio market on its side, you will not find any radio that will fit in more cars out of the box than this one, we guarantee it!

Unit specs:

- LCD Display w/ enhanced viewing angle & daylight compatible
- LCD Display shows MP3/WMA track names
- AM/FM PLL tuner w/ 30 presets
- 60W x 4 (Integrated amplifier)
- 2pr RCA pre amp outputs to add an external amplifier
- on board CD Changer controller output (to control optional 10 Disc changer) will work with any Sanyo compatible unit
- Front mounted USB port, plug in any USB flash drive and play MP3 / WMA files directly off the drive
- Patent Pending INFINIMOUNT adjustable shaft system w/ removable Universal bracket (included)
- Insulated bracket system and external shaft system reduces electrical noise inherent in older vehicles
- Front Aux input, plug in any MP3 player or other portable device, (cell phone, etc)
- Full Function 18 key remote control Note, you don't need the optional cable unless you're remote mounting it
- Main unit is remote mountable and comes with a metal U bracket for mounting under the seat or a glove box
- OPTIONAL external IR sensor w/ 94" cable, allows for easy remote operation via the included remote control
- Adjustable faceplate angle, allows mounting of faceplate display to virtually any dash
- Small 3.54" w X 6.57" d X 1.57" h installation size.

RS-MODEL1 all RetroSound model 1 AM/FM radio with face kit
kit (specify year)



1962 – 1979 Nova & Acadian Catalogue Volume 9

PHONE: (905)627-4527 ORDERS 1-866-767-2787 FAX (905)627-3210

RetroSound™

Modern Sound for your Classic

Why purchase RetroSound™ speakers over your original or "other" commercially available speakers for your classic car?
 Check out the exploded view below to learn more about the detail and quality that goes into each speaker we make!

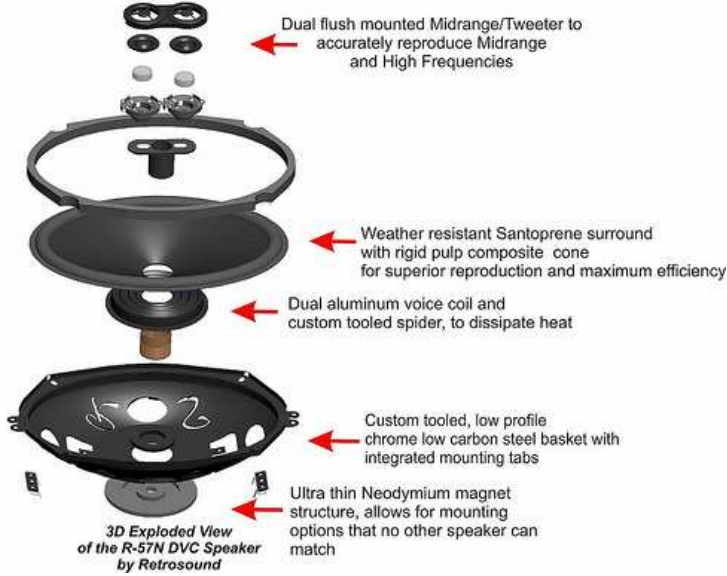

This is an optional accessory for the RetroSound Model One radio, it allows you to remotely operate the model one if the main unit is out of view. Simply install the Infrared receiver in an unobtrusive portion of your dash (Cigarette lighter, blank area on the dash, etc) and if you've mounted the Model one in a glove box, or under the seat, you can still use the remote that came with your Model One to control all functions of your unit! The Model one unit can be used WITHOUT the shafts attached, so this gives some amazing flexibility for a self contained "mini" in vehicle entertainment system that has modern digital playback capabilities!

| | | | |
|--------|-------|--|------|
| RS-41N | 62-65 | Chevy 4"X10" 150 watt DVC speaker | each |
| IREYE | all | 94" Remote IR Cable for the RetroSound Model One | each |



1962 – 1979 Nova & Acadian Catalogue Volume 9

PHONE: (905)627-4527 ORDERS 1-866-767-2787 FAX (905)627-3210

Custom Autosound

These Custom Autosound Radios fit into most original radio openings, which eliminates the need to cut the dash to install modern equipment. Recently improved systems feature higher wattage and auxiliary inputs as well as other features!



USA-1 features

If you want great sound at an affordable price then this is the radio for you! A quick review of the features and you'll realize why it's our best seller. Now with 200 watts and auxiliary input for iPod, MP3, satellite radio, etc. This radio has outstanding features.

- AM-FM Stereo
- Auto Reverse Cassette
- 200 watts (4x50)
- Auxiliary Input
- Electronic Tuning and Volume Control
- Pre-set Scan
- Digital Clock
- Best Station Memory
- 30 Pre-sets (12AM-18FM)
- 4 Channel RCA Pre-outs
- 4 way Fader
- Separate Bass and Treble
- Fast Forward and Rewind
- Digital Clock
- Power Antenna Lead



USA-01 BLK features

- Same as above with black face

(USA-01blk shown in 69 - 72 Chevelle)



USA-2 features

A great look and sound at an awesome price. This Concours series USA-2 radio has **no cassette** but comes with Auxiliary Input for iPod, MP3, Satellite radio, etc. Classic features with a classic look. These exciting features include:

- AM-FM Stereo
- 200 Watts (4x50)
- Auxiliary Input
- Digital Clock
- Electronic Tuner
- 30 Pre-sets (12AM-18FM)
- 4 Channel RCA Pre-outs
- 4 way Fader
- Seek and Scan tuning
- Chrome Nosepiece or Black Nosepiece
- Power Antenna Lead

(shown in '72 Olds Cutlass)

1962 – 1979 Nova & Acadian Catalogue Volume 9

PHONE: (905)627-4527 ORDERS 1-866-767-2787 FAX (905)627-3210

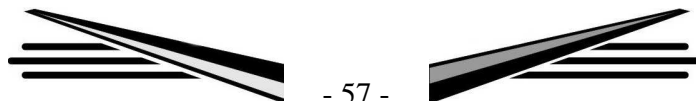

Custom Autosound



**Purchase with the
USA-CD10 10 CD Disc
Changer and save!
(USA-5PK)**

USA-5 Features

You get the best of both worlds, yesterdays cosmetics with today's sound. This radio will control all functions of the optional Custom Autosound 10 disc CD changer from the buttons on the radio. All radios are supplied with the correct surround bezel for your car. Check out these exciting features. AM-FM Stereo • Auto Reverse Cassette • CD Changer Controller • **240 Watts (4x60)** • **Electronic Tuning and Volume Control** • 4 Channel RCA pre-out • 30 Pre-sets (12AM-18FM) • Separate Bass & Treble • 4 way Fader • Locking Fast Forward / Rewind • Electronic Seek Tuning • 10 disc Changer Optional • Chrome Face also available in Black Face • All Functions of the CD Changer Controlled from Radio Pushbuttons NO External Controls or FM Modulation Required! - CD track disc/scan/repeat/random play

(shown in a 67-68 Mustang)



**Purchase with the
USA-CD10 10 CD
Disc Changer and
save!
(USA-6PK)**

USA-630 Features

If you want to keep the classic look of your dash, but demand the great sound that today's modern electronics offer, this is the radio you've been looking for. This AM/FM Stereo unit is packed with features, including a whopping •AM-FM Stereo • 240 Watts • **USB Port for Flash Memory MP3/WMA Playback** • **Direct 10 CD Changer Control** • Alpha Numeric id3 Display for MP3/WMA files •Electronic Tuning and Volume Control • 4 way Fader • Left Right Balance • Digital Clock • 2 Channel RCA Auxiliary Input for Satellite / iPod etc. • 16 Pre-sets (12FM-4AM) • 4 Channel RCA Pre-outs • Separate Bass and Treble • USA/Euro Tuner • Power Antenna Lead • **Note:** This radio does not include a cassette player

(shown in a 57 Chevrolet)



**Purchase with the USA-CD10
10 CD Disc Changer and
save!
(SS-PK)**

SS (Secretaudio System)

Leave your original radio in the dash and control this stereo system by 'RF' (radio frequency) remote control from up to 80' away. The LCD display can be mounted almost anywhere (bracket and flush mount bezel included) or even hidden out of sight and the 140 watt tuner/amplifier unit can be hidden behind the dash or under the seat. **This system features: 140 watts (4x35) - AM/FM Stereo - Separate Bass and Treble - CD Changer control from remote or LCD panel (6 or 10 disc CD Changer optional) - 4 channel RCA pre-outs - 4 way fader - Electronic seek and scan tuning - 12AM and 18FM station memory**

1962 – 1979 Nova & Acadian Catalogue Volume 9

PHONE: (905)627-4527 ORDERS 1-866-767-2787 FAX (905)627-3210

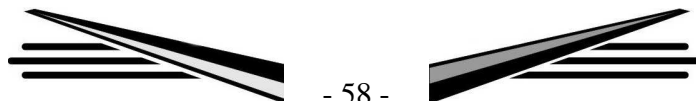

Custom Autosound

Enhance your sound quality with these quality plastic moulded kick panel speaker assemblies! These kicks sounds great and affords a "no modification" fit! These speakers are a perfect fit into the original kick panel area and features 6.5" three way speakers at **60 or 80 watts** power handling! Or if you want you can upgrade these to **Pioneer 120 or 160 watt** speakers. (most models) **Note:** Without speakers also available (selected models only)



1962-65 Nova Coupe

Available with:
Custom Autosound 4"x6" 60 watt
speakers

KNOV-62/5

Pioneer 4"x6" 120 watt speakers

PIO-KNOV-62/5



1962-63 Nova Convertible

Available with:
Custom Autosound 4"x6" 60 watt
speakers

KNOV-62/3

Pioneer 4"x6" 120 watt speakers

PIO-KNOV-62/3



1966-67 Nova without Factory AIR

Available with:
Custom Autosound 6½" 80 watt
speakers

KNOV-66/7

Pioneer 6½" 160 watt speakers

PIO-KNOV-66/7



1968-72 Nova without Factory AIR

Available with:
Custom Autosound 6½" 80 watt
speakers

KNOV-68/2

Pioneer 6½" 160 watt speakers

PIO-KNOV-68/2

Dual Front Speakers

1962 – 1979 Nova & Acadian Catalogue Volume 9

PHONE: (905)627-4527 ORDERS 1-866-767-2787 FAX (905)627-3210



Custom Autosound

Since at least 2 speakers are required for stereo units Custom Autosound has designed and manufactured dual speaker assemblies! These **30 watt** assemblies are pre-wired to plug in instantly to our radios! These speakers can also be used as a rear speaker in some vehicles! Some vehicles need a bracket to aid in installation of these speakers and are pre-attached for you. Please call and we'll get what you need.

Want more power in your speakers? How about our Kenwood **50 watt** dual front speaker upgrade?



Dual Voice Coils (DVC)

Dual Voice Coils will give the best possible sound and power handling from OEM speaker locations. They give up to 70% more cone area than the conventional speaker set-up and provide **140 watts**. Both stereo channels connect to one speaker. Call us to determine which series your vehicle requires.



Custom Autosound USA-CD10 10 CD Disc Changer

For use with new model Secretaudio SS, USA-5 and USA-6. (Manufactured after 05/03) this 10 disc changer connects directly with Custom Autosound radios. On the USA models, the changer works off

the buttons on the radio face, and for the Secretaudio SS model, the changer works off the RF (radio frequency) remote control. CD-10 features: 1 bit times oversampling, twin digital-to-analog converter, 3 beam lase tracking, disc select up/down, track up/down, 2 way scan and shuffle, play and pause control, program repeat, antishock and vibration free design -horizontal or vertical mounting. CD-10 Dimensions: 9 3/4" (w) x 3 1/2" (h) x 6 3/4" (d)



ANTUV-HIDE Hidden Amplified Antenna

For the best AM/FM reception nothing works better than a 31" vertically mounted antenna mast. Recognizing that application is impossible on some vehicles our improved amplified antenna is the next best thing. Mounts on the

inside top of windshield (or rear package tray) for best performance. Note radio signals cannot penetrate metal. Do not attempt to hide this unit under the dash. Requires 12 volts.

Application Chart

Dots Indicate Which Radio Models are Available for Specific Vehicles.

| MODEL | YEAR | 1 | 2 | 5 | 6 | Kickpanels | Kick Upgrade | SPKR | DVC |
|-------|------------------|---|---|---|---|------------|--------------|------|------|
| NOVA | 66-67 (W/O AIR) | • | • | • | • | KNOV-66/7 | PIOKNOV-66/7 | 2008 | 4008 |
| NOVA | 66-67 (WITH AIR) | • | • | • | • | | | 2009 | 4009 |
| NOVA | 68-72 (W/O AIR) | • | • | • | • | KNOV-68/2 | PIOKNOV-68/2 | 2001 | 4001 |
| NOVA | 68-72 (WITH AIR) | • | • | • | • | | | 2002 | |
| NOVA | 73-76 (W/O AIR) | • | • | • | • | | | 2001 | 4001 |
| NOVA | 73-76(WITH AIR) | • | • | • | • | | | 2002 | |
| NOVA | 62-65 | • | • | • | • | KNOV-62/5 | PIONOV-62/5 | 1001 | 3001 |

1962 – 1979 Nova & Acadian Catalogue Volume 9

PHONE: (905)627-4527 ORDERS 1-866-767-2787 FAX (905)627-3210

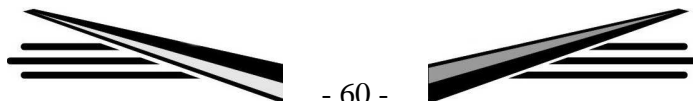

Index

| | |
|--|--|
| <p>63-64 PEAK MOULDINGS 8</p> <p>A-ARM SEALS 13</p> <p>AIR CLEANERS 22</p> <p>ANTENNAS 10</p> <p>ARM RESTS 47</p> <p>ASH TRAYS 48</p> <p>BACK-UP LAMP LENSES 16</p> <p>BACKUP LAMP SWITCH ASSEMBLIES 18</p> <p>BATTERY TRAYS & RELATED 22</p> <p>BODY ASSEMBLY FASTENER KITS 37</p> <p>BODY BUMPERS 15</p> <p>BODY TO FRAME CUSHIONS 15</p> <p>BRAKE AND CLUTCH PADS 14</p> <p>BRAKE AND CLUTCH PEDAL ASSEMBLIES 23</p> <p>BRAKE HOSES 27</p> <p>BRAKE LAMP SWITCH 19</p> <p>BUCKET SEAT COMPONENTS 47</p> <p>BUMPERS 10</p> <p>CAR COVERS 50</p> <p>CARPETS 49</p> <p>CLASSIC UPDATE KIT 21</p> <p>CLUTCH PARTS 23</p> <p>COAT HOOKS 49</p> <p>CONSOLE GAUGE PACKAGE 53</p> <p>CONSOLE GAUGES 52</p> <p>CONSOLES & RELATED 53</p> <p>CONVERTIBLE ITEMS 49</p> <p>CONVERTIBLE TENSION CABLES 49</p> <p>CONVERTIBLE TOP HOSES 49</p> <p>CONVERTIBLE TOP MOTOR/PUMP ASSEMBLY 49</p> <p>CONVERTIBLE TOP RUBBERS 12</p> <p>COWL TO FENDER SHIELDS 14</p> <p>CUSTOM AUTOSOUND RADIOS 57</p> <p>DASH PADS 51</p> <p>DASH RELATED TRIM 53</p> <p>DASH REPAIR PANEL 43</p> <p>DECALS 34</p> <p>DISC BRAKE CONVERSION KITS 28</p> <p>DISC BRAKE PARTS 27</p> <p>DOME LAMPS 52</p> <p>DOOR ALIGNMENT WEDGES 32</p> <p>DOOR FRAME MOULDINGS 8</p> <p>DOOR GLASS FELT LINERS 13</p> <p>DOOR GLASS FRAMES 32</p> <p>DOOR HANDLE, INTERIOR 51</p> <p>DOOR HINGES 32</p> <p>DOOR JAMB SWITCHES 18</p> <p>DOOR LATCHES 32</p> <p>DOOR LOCK CYLINDERS 33</p> <p>DOOR LOCK KNOBS 48</p> <p>DOOR LOCK STRIKERS 32</p> <p>DOOR SILL PLATES 49</p> <p>DOOR WEATHERSTRIPS 12</p> <p>DOORS 40</p> <p>DROP-OFF SEE TRUNK SIDE FILLER PANELS</p> <p>DUAL SPEAKERS 60</p> <p>EXTERIOR TRIM SCREW KITS 37</p> | <p>FACTORY ASSEMBLY MANUALS 44</p> <p>FAN SHROUDS 30</p> <p>FIREWALL PADS 51</p> <p>FIREWALL WIRING GUTTER 30</p> <p>FISHER BODY MANUAL 44</p> <p>FLOOR PANS 41</p> <p>FRONT BRAKE LINES 24</p> <p>FRONT END SHEET METAL FASTENER KITS 37</p> <p>FRONT FENDER EMBLEMS 4</p> <p>FRONT FENDERS 39</p> <p>FRONT INNER FENDERS 40</p> <p>FRONT TO REAR BRAKE LINES 24</p> <p>FRONT TO REAR FUEL LINES 26</p> <p>FRONT WINDSHIELD SEALS 13</p> <p>FUEL PUMP TO CARB LINES 24</p> <p>GAS PEDALS 14</p> <p>GAS TANKS & RELATED 23</p> <p>GLOVE BOX CYLINDERS 33</p> <p>GLOVE BOX LINERS 51</p> <p>GRILLE EMBLEMS 4</p> <p>GRILLE TO BUMPER FILLER PANELS 39</p> <p>GRILLES 6, 7</p> <p>HATCHBACK WEATHERSTRIPS 13</p> <p>HEADLAMP ADJUSTER KITS 17</p> <p>HEADLAMP BEZELS 6, 7</p> <p>HEADLAMP BUCKET MUD CAPS 39</p> <p>HEADLAMP SWITCHES 18</p> <p>HEADLINERS 48</p> <p>HEADREST COVERS 47</p> <p>HEATER CONTROL 18</p> <p>HEATER HOSES 30</p> <p>HEATER SEALS 14</p> <p>HOOD HINGES 22</p> <p>HOOD INSULATION PADS & CLIPS 22</p> <p>HOOD LIP MOULDINGS 6, 7</p> <p>HOOD LOUVERS & BEZELS 4</p> <p>HOOD SPRINGS 22</p> <p>HOOD TO COWL SEALS 13</p> <p>HOODS 39</p> <p>HORN RELAYS 19</p> <p>HORNS 19</p> <p>IGNITION CYLINDERS 18, 33</p> <p>IGNITION SWITCHES 18</p> <p>INNER FENDER WIRE RETAINERS 30</p> <p>INSIDE WINDOW TRIM 49</p> <p>INTERIOR EMBLEMS 52</p> <p>INTERIOR MIRRORS 52</p> <p>INTERIOR SIDE PANELS 47</p> <p>INTERIOR TRIM SCREW KITS 37</p> <p>KEY BLANKS 33</p> <p>KICK PANEL SPEAKERS 59</p> <p>KICK PANELS 51</p> <p>LENS GASKETS 14</p> <p>LICENSE LAMP LENSES 17</p> <p>MAIN FIREWALL WIRING HARNESS SEAL 14</p> <p>MARKER LAMP ASSEMBLIES 17</p> |
|--|--|

1962 – 1979 Nova & Acadian Catalogue Volume 9

PHONE: (905)627-4527 ORDERS 1-866-767-2787 FAX (905)627-3210



Index

| | | | |
|--|-------|---|----|
| MARKER LAMP BEZELS | 5, 17 | SEAT BELTS | 54 |
| MASTER CHASSIS ASSEMBLY KITS | 37 | SEAT COVER INSTALLATION KIT | 46 |
| MIRRORS, INTERIOR | 52 | SEAT COVERS | 46 |
| MIRRORS, OUTSIDE | 10 | SHIFT BOOT & RETAINER | 53 |
| MOTOR MOUNT BRACKETS | 31 | SHOP MANUALS | 44 |
| NEUTRAL SAFETY SWITCH | 18 | SIDE MOULDINGS | 8 |
| NOVA RALLY RIM | 9 | SPARK PLUG HEAT SHIELDS | 30 |
| OIL FILLER CAP | 30 | SS RIM | 9 |
| OUTSIDE DOOR HANDLES | 9 | SS WHEEL NUT | 9 |
| OUTSIDE DOOR MIRRORS | 10 | STEERING COLUMN SEALS | 14 |
| OWNERS MANUALS | 44 | STEERING COLUMNS | 45 |
| PACKAGE TRAYS & INSULATION | 50 | STEERING SHAFT RAG JOINT REPAIR KIT | 30 |
| PAINT GASKET KITS | 15 | STEERING WHEELS & RELATED | 45 |
| PARK BRAKE CABLES | 27 | SUBFRAME MOUNT REPAIR KIT | 15 |
| PARK LAMP ASSEMBLIES | 16 | SUNVISORS | 48 |
| PARK LAMP BEZELS | 6 | SUSPENSION | 29 |
| PARK LAMP LENSES | 16 | TAIL LAMP ASSEMBLIES | 16 |
| POWER STEERING | 29 | TAIL LAMP LENSES | 16 |
| POWER WINDOW SWITCHES | 18 | TAIL LAMP PANELS | 42 |
| PRINTED CIRCUIT | 19 | TILT WHEEL RELEASE LEVERS | 45 |
| QUARTER GLASS CHANNEL KIT | 13 | TRANSMISSION COOLER LINES | 26 |
| QUARTER WINDOW DOOR JAMB "U" SEALS | 13 | TRANSMISSION MOUNT SUPPORT | 31 |
| QUARTER WINDOW SEALS | 13 | TRANSMISSION VACUUM LINES | 26 |
| RADIATOR AND HEATER HOSE CLAMPS | 30 | TRIM RINGS | 9 |
| RADIATOR HOSES | 30 | TRUNK EMBLEMS | 5 |
| RADIATOR SUPPORTS | 40 | TRUNK FLOORS | 41 |
| RADIOS | 57 | TRUNK LIDS | 43 |
| RALLY WHEEL CAPS | 9 | TRUNK LOCK CYLINDERS | 33 |
| REAR AXLE BRAKE LINES | 24 | TRUNK MATS | 51 |
| REAR BUMPER TO BODY SEALS | 14 | TRUNK SIDE FILLER PANELS | 42 |
| REAR COVE MOULDINGS | 7 | TRUNK WEATHERSTRIPS | 13 |
| REAR DISC CONVERSION KIT | 29 | TURN SIGNAL LEVERS | 45 |
| REAR FRAME RAILS | 42 | TURN SIGNAL SWITCHES & RELATED | 19 |
| REAR OUTER WHEEL HOUSES | 43 | VAPOUR RETURN LINES | 26 |
| REAR PANEL EMBLEMS | 5 | VENT WINDOW FRAMES | 32 |
| REAR PANEL MOULDINGS | 11 | VENT WINDOW HANDLES | 52 |
| REAR PANEL MOULDINGS | 11 | VENT WINDOW SEALS | 13 |
| REAR QUARTER EMBLEMS | 4 | VINYL TOPS | 50 |
| REAR QUARTER WINDOW CORNER MOULDINGS | 9 | WAGON TAILGATE SEAL | 13 |
| REAR QUARTERS | 40 | WATER PUMP BYPASS HOSE | 30 |
| REAR SEAT TO TRUNK BOARDS & INSULATION | 51 | WEATHERSTRIP ADHESIVE | 13 |
| REAR WINDOW MOULDINGS | 8 | WELL OPENING MOULDINGS | 8 |
| REAR WINDOW SEALS | 13 | WHEEL CYLINDERS | 27 |
| REAR WINDOW TO TRUNK PANELS | 42 | WHEEL EMBLEMS | 9 |
| RIMS | 9 | WINDLACE END CAPS | 49 |
| ROCKER MOULDINGS | 8 | WINDOW CRANKS | 51 |
| ROCKER PANELS | 42 | WINDOWFELT KITS | 12 |
| ROOF DRIP MOULDINGS | 8 | WINDSHIELD MOULDINGS | 8 |
| ROOF RAIL WEATHERSTRIPS | 12 | WINDSHIELD PILLAR POST SEALS | 12 |
| SALES BROCHURES | 44 | WINDSHIELD WASHERS | 30 |
| | | WINDSHIELD WIPER MOTOR GROMMETS | 14 |
| | | WIRING HARNESES | 19 |

1962 – 1979 Nova & Acadian Catalogue Volume 9

PHONE: (905)627-4527 ORDERS 1-866-767-2787 FAX (905)627-3210



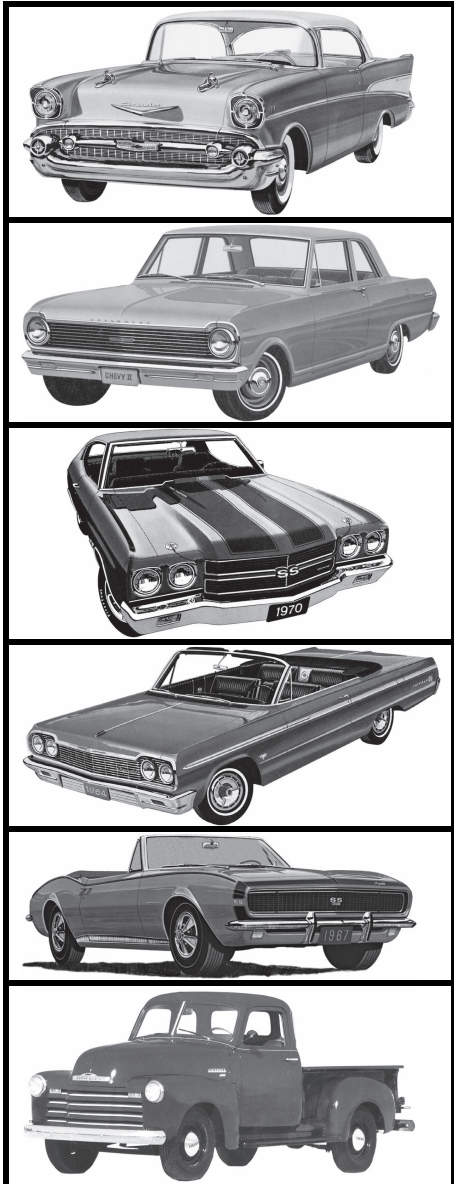

ANTIQUE CHEVROLET PARTS

OUR PRODUCTS ARE DESIGNED TO HELP RESTORE

150s, 210s, NOMADS, BELAIRS, IMPALAS,
BISCAYNES, LAURENTIENS,
PARISIENNES, STRATO-CHIEFS,
MALIBUS, EL CAMINOS, BEAUMONTS,
MONTE CARLOS, CHEVY II & NOVAS,
ACADIANS, CAMAROS, BROOKWOODS,
YEOMANS, BRIARWOODS, STEPSIDE &
FLEETSIDE CHEVROLET & GMC TRUCKS

AS WELL AS PARTS FOR OTHER GM MAKES AND MODELS.

LOOK FAMILIAR?
WE HAVE YOUR PARTS

WE STRIVE TO HAVE THE LARGEST SELECTION OF "FACTORY ORIGINAL" BODY PANELS; AMERICAN OR TAIWAN MADE FROM HEAVY GAUGE SHEET METAL. WE ARE THE #1 SUPPLIER OF AUTHENTIC INTERIORS FOR YOUR COLLECTABLE CHEVY. ALL OF OUR MATERIALS ARE PRODUCED TO FACTORY SPECIFICATIONS, WHETHER IT IS SEAT COVERS, SIDE PANELS, CARPETS, HEADLINERS, OR ANY OTHER INTERIOR PARTS, WE CAN GET IT. EMBLEMS, WEATHERSTRIPPING, MOULDINGS, LENSES, GASKETS, GLASS CHANNELS, TRUNK MATS, MANUALS OR ANYTHING ELSE YOU NEED, JUST ASK!

